

SINGLE-PHASE RESIDENTIAL GAS LTS ELECTRIC DRAWING (AUSTRALIA)

Project	SM5W600013
Rated voltage	230V (1PH+N)
Frequency	50Hz
Auxiliary	N/A

Table of contents

SOMMARIO_PAGINE_PRAMAC_dinamico

Assignment	Page	Page description	Date	Edited by
+0DOC				
	1	Title page / cover sheet	22/06/2018	JOSEANGEL.JIMENEZ
	2	Índice de páginas : +0DOC/1 - +4END/5	16/10/2018	JOSEANGEL.JIMENEZ
+2P				
	4	POWER	16/10/2018	JOSEANGEL.JIMENEZ
+3C				
	8	CONTROL	16/10/2018	JOSEANGEL.JIMENEZ
	9	LOAD, GENSET & MAINS INTERCONNECTION	16/10/2018	JOSEANGEL.JIMENEZ
+4END				
	1	Terminal diagram =+	16/10/2018	JOSEANGEL.JIMENEZ
	2	Terminal diagram =+2P-GENSET	16/10/2018	JOSEANGEL.JIMENEZ
	3	Terminal diagram =+2P-LOAD	16/10/2018	JOSEANGEL.JIMENEZ
	4	Terminal diagram =+2P-MAINS	16/10/2018	JOSEANGEL.JIMENEZ
	5	Terminal diagram =+3C-CONTROL	16/10/2018	JOSEANGEL.JIMENEZ

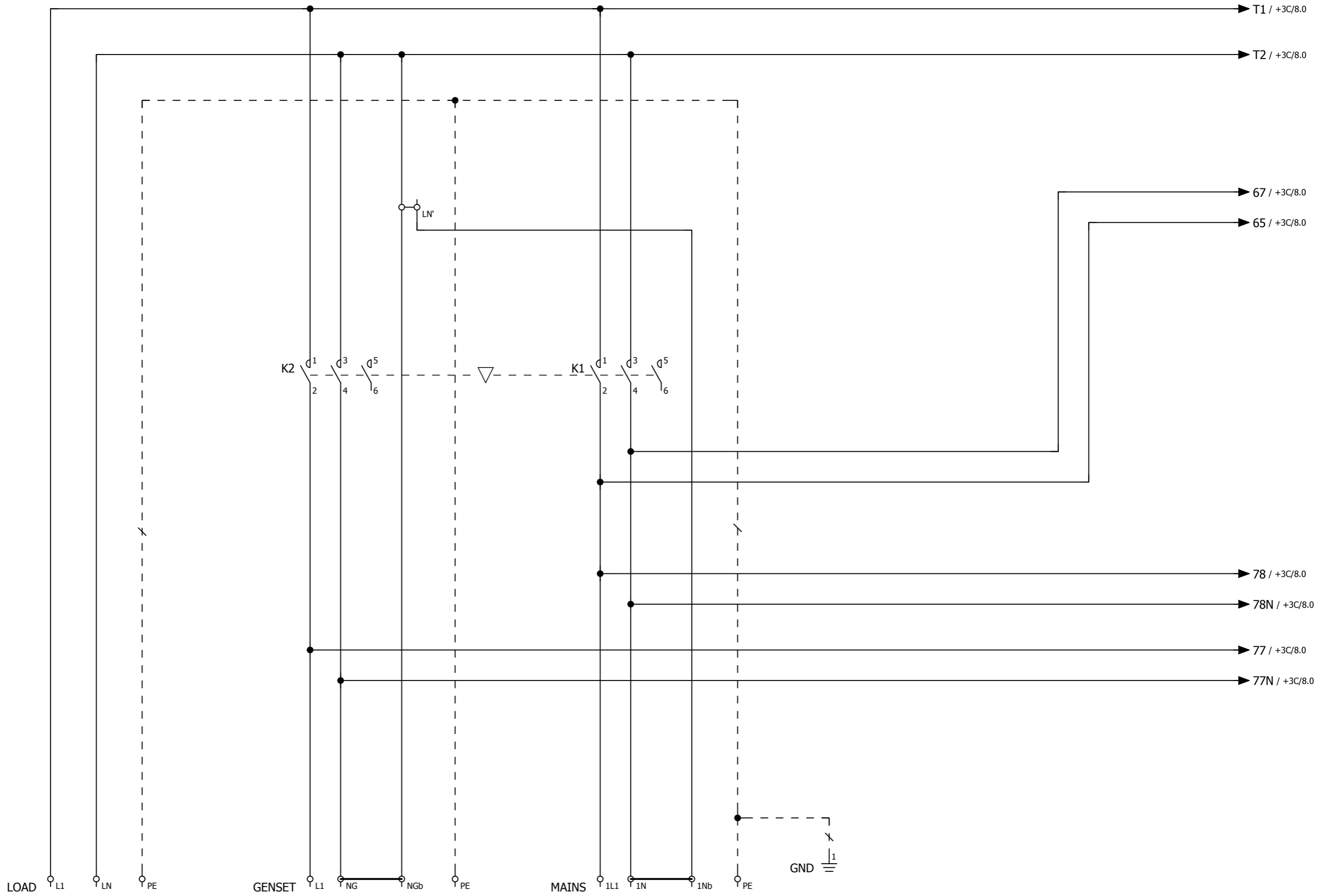

CHECK INTERCONNECTION MODES BEFORE WIRING

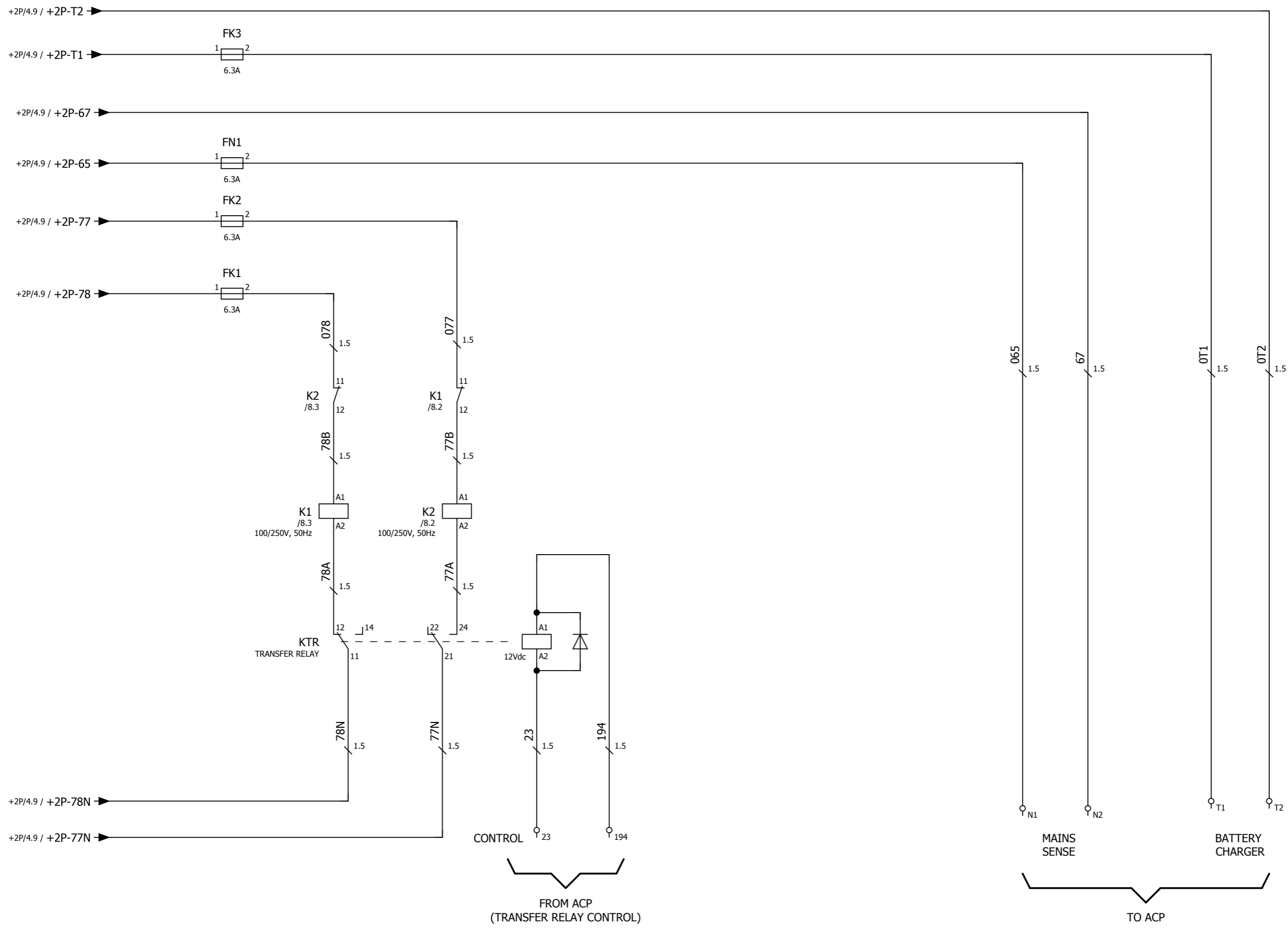

LTS POWER TERMINALS

2 Modes of connection:

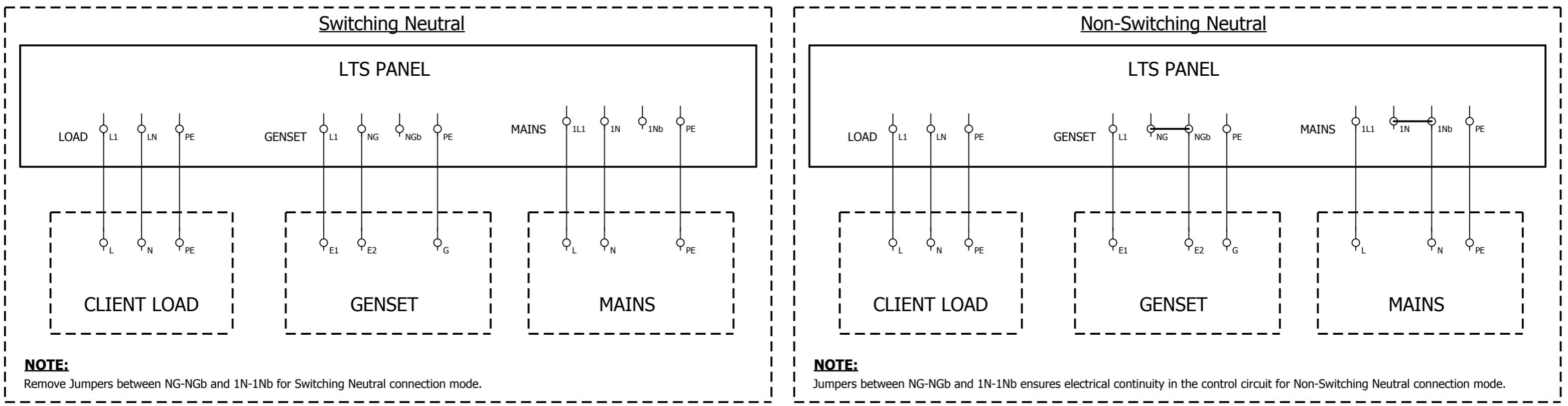

LTS CONTROL TERMINALS

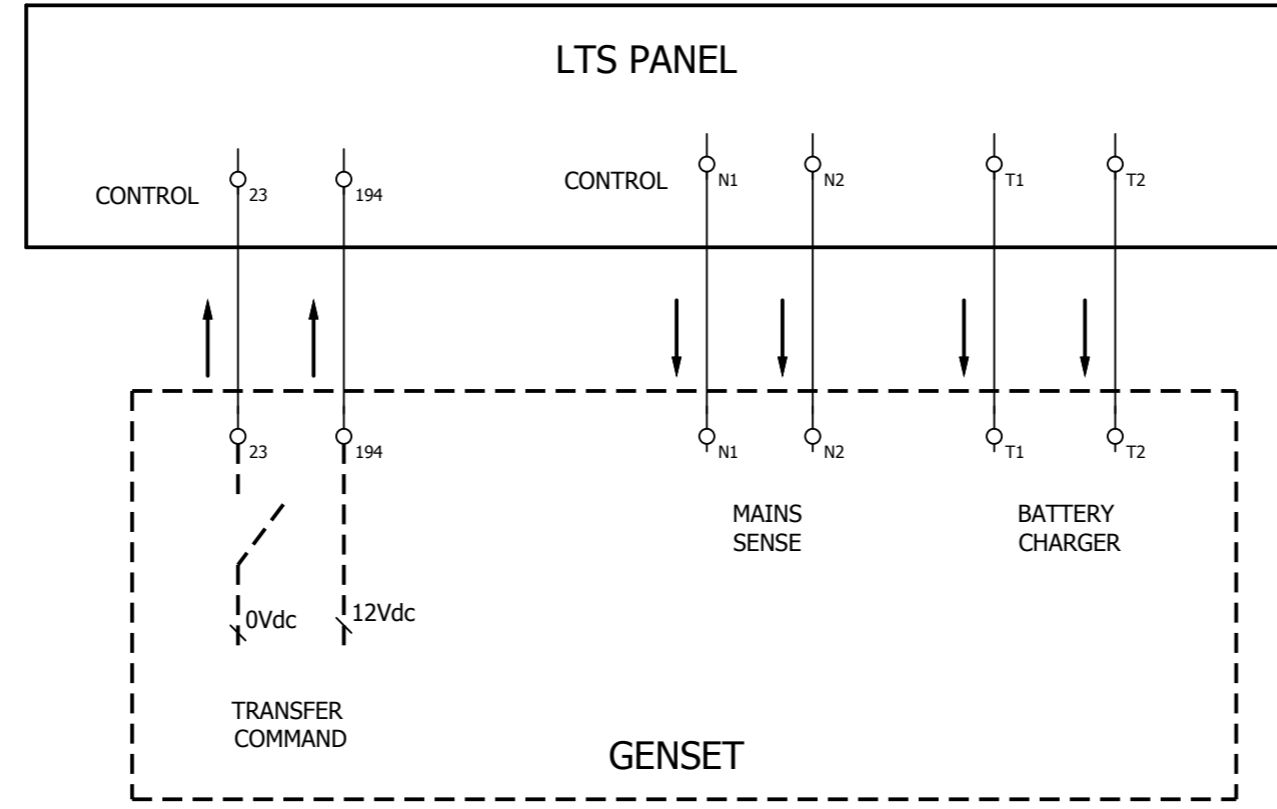

Terminal diagram

MORSETTIERE

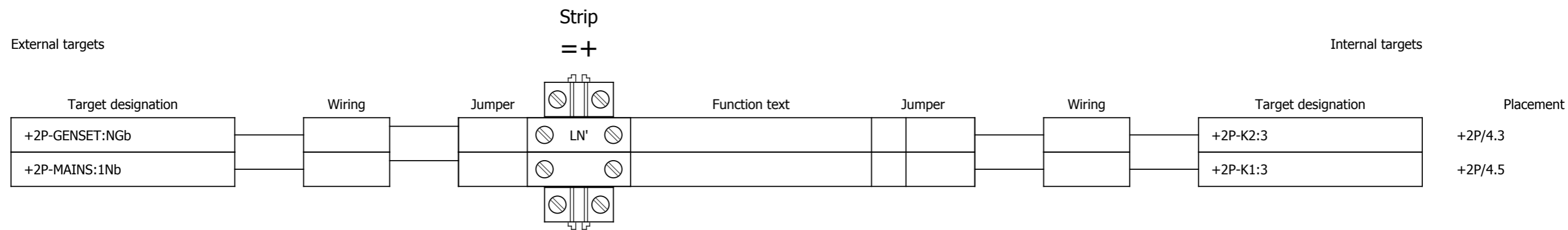

Terminal diagram

MORSETTIERE

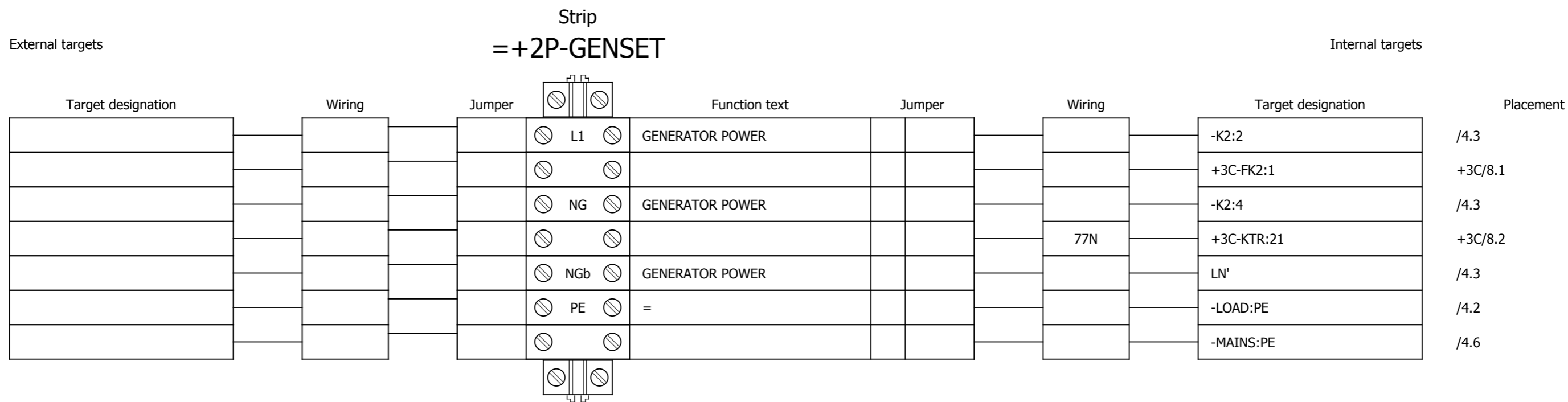

Terminal diagram

MORSETTIERE

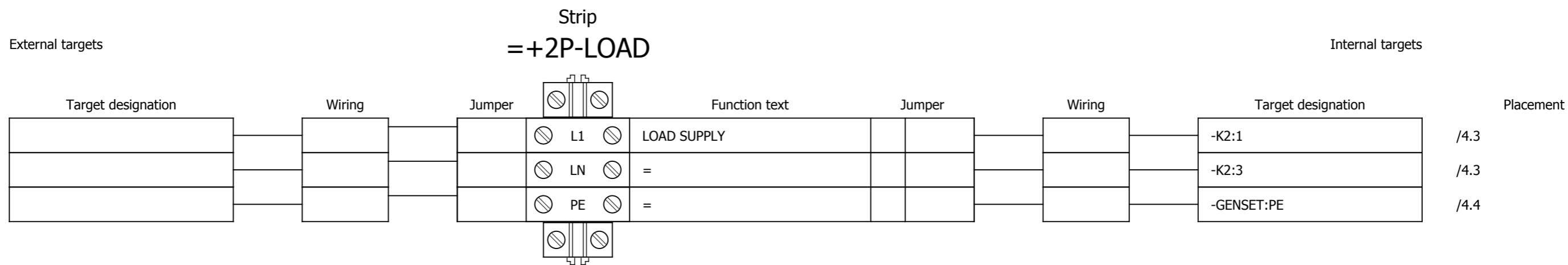

Terminal diagram

MORSETTIERE

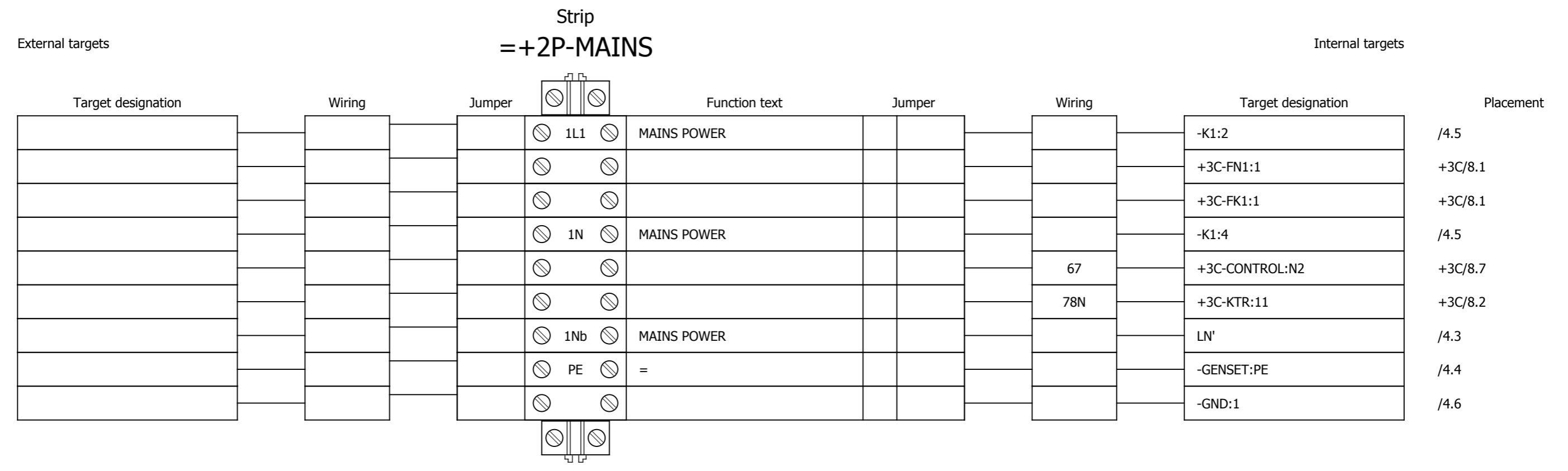

Terminal diagram

MORSETTIERE

