

# AC M2 OLED Meter Instructions

PN 1836/ PN 1837 / PN 1838

## Installation Checklist

- Check for components included
- Read Warning and Cautions
- Read QuickStart Installation Guide for mounting instructions
- Read System Overview, Mounting Considerations, Detailed Wiring, and Sensing Description
- Read QuickStart Installation Guide for installation notes
- Follow Initial System Setup instructions
- Configure Displays
- Configure Alarms
- Configure Relays

Display Size	55mm x 28mm
Power Supply	7V–70V DC
Power Consumption	0.3W–1.0W*

\* Variable with voltage, display intensity, and sleep mode

## Regulatory

Monitor face is IP66 – protected against powerful water jets when installed according to instructions

## 1836 Specifications

### Current

Range	0A–150A (300A optional)†
Resolution (100 to 150)	1A
Resolution (0.0 to 99.9)	0.1A
Current Transformer Included	1 × PN 8256 (150A /50mA)
Alarm / Relay Activation	High and Low Current

## 1837 Specifications

### Voltage

Range	50V–250V AC (RMS)
Resolution	1V AC
Alarm / Relay Activation	High and Low Voltage

## 1838 Specifications

### Voltage

Range	50V–250V AC (RMS)
Resolution	1V AC

### Current

Range	0A–150A (300A optional)†
Resolution (100 to 150)	1A
Resolution (0.0 to 99.9)	0.1A
Current Transformer Included	1 × PN 8256 (150A /50mA)
Alarm / Relay Activation	High and Low Voltage, Current, and Frequency

### Frequency

Range	40Hz–90Hz
Resolution	1 Hz

### Power

Range	0W–45kW
Resolution (0W–9990W)	10W
Resolution (10kW–45kW)	0.1kW

† Will achieve 300A with an optional current transformer PN 1829

## Components Included

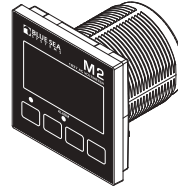

M2 Head Unit

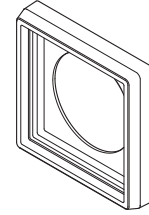

Surface Mount Bezel and Seal

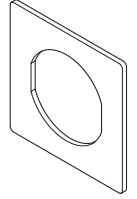

Surface Mount Gasket

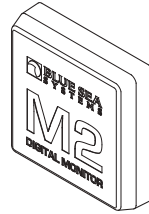

Surface Mount Cover

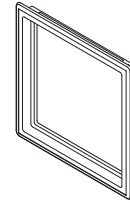

Flat Mount Bezel

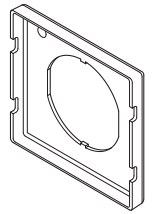

Flat Mount Clamp



Mounting Ring



Mounting Nut



AC Current Transformer  
8256 (1X)  
1836 and 1838 Only

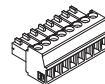

Connector



Connector  
1837 and 1838 Only



Screwdriver  
Retail Package Only

## 360 Panel Mounting Kit (PN 1525 sold separately)

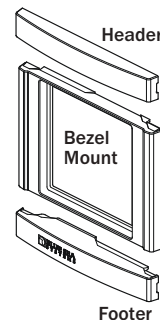

Footer

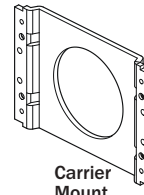

Carrier Mount

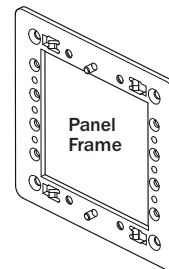

Panel Frame

#6-32 x 1/4"  
Flat Head  
Machine Screws  
(4X)

#6-32 x 3/8"  
Flat Head  
Machine Screws  
(4X)

#8 x 1/2"  
Flat Head Sheet  
Metal Screws  
(4X)

# Resource Information

AC Current Measurement <http://blueseas.com/viewresource/86>

## Warning And Caution Symbols

**WARNING:** The ⚠ symbol refers to possible injury to the user or significant damage to the meter if the user does not follow the procedures.

**CAUTION:** The ⚠ symbol refers to restrictions and rules with regard to preventing damage to the meter.

### WARNING ⚠

- Verify that all AC sources are disconnected before connecting or disconnecting the current transformer. Failure to do so will generate lethal voltages on the current transformer.
- If you are not knowledgeable about electrical systems, have an electrical professional install this unit. The diagrams in these instructions pertain to the installation of M2 Digital Meters and not to the overall wiring of the vessel.
- If an inverter is installed on the vessel, its power leads must be disconnected at the battery before the meter is installed.
- If an AC generator is installed on the vessel, it must be stopped and rendered inoperable before the meter is installed.
- Verify that no other DC or AC sources are connected to the vessel's wiring before installing the meter.
- If the meter must be removed, connect the current transformer leads together before restoring power to the AC system. (P/Ns 1836 & 1838 Only)

### CAUTION ⚠

- The back of the unit is not waterproof. Do not install where the back of the meter is exposed to water.

## Installation

1. Make all connections to the meter's terminal block before connecting the terminal block to the unit.  
Keep hands away from the terminal block when applying power to the meter.
2. As the final DC connection, insert a fuse into the in-line fuse holder on the wire to the positive (+) battery terminal.

## Mounting Templates

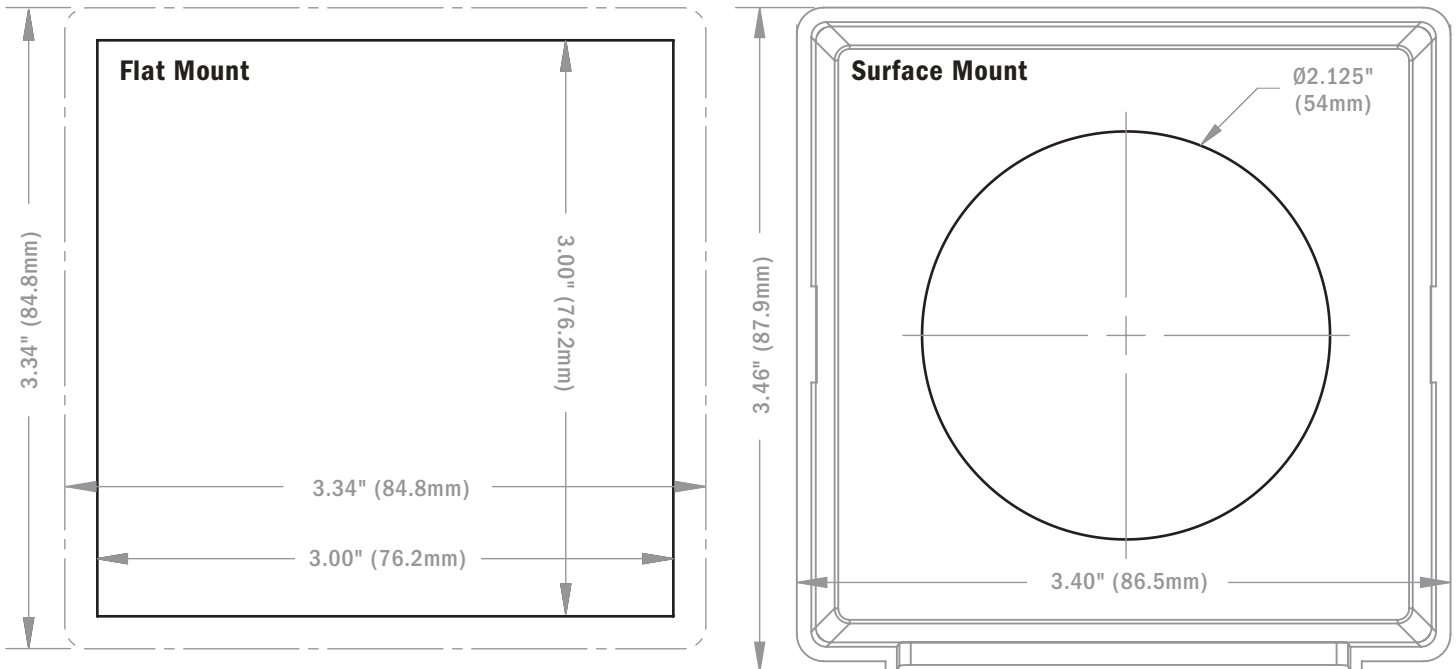

# Mounting Considerations

M2 Digital Meters have three mounting methods: Surface mount, Flat panel mount, and 360 panel mount. When surface mounted per instructions the unit face is waterproof to IP66. Flat panel and 360 mounting systems are not waterproof. The unit should not be flat panel or 360 mounted if used in an exposed location. For all mountings, the back of the unit is not waterproof and must be kept dry.

## Flat Mount

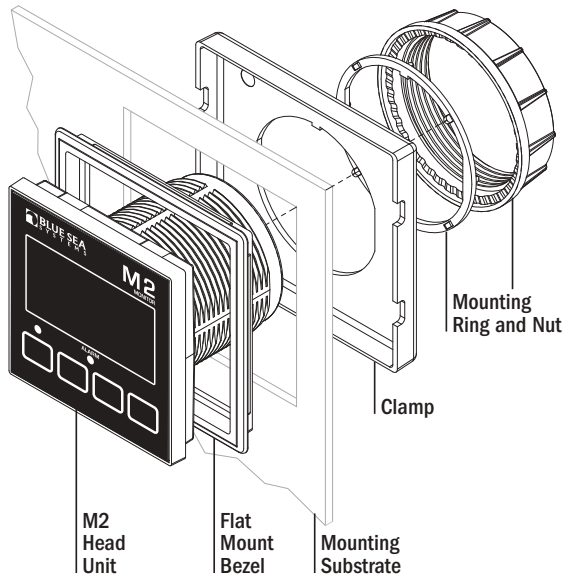

## Surface Mount

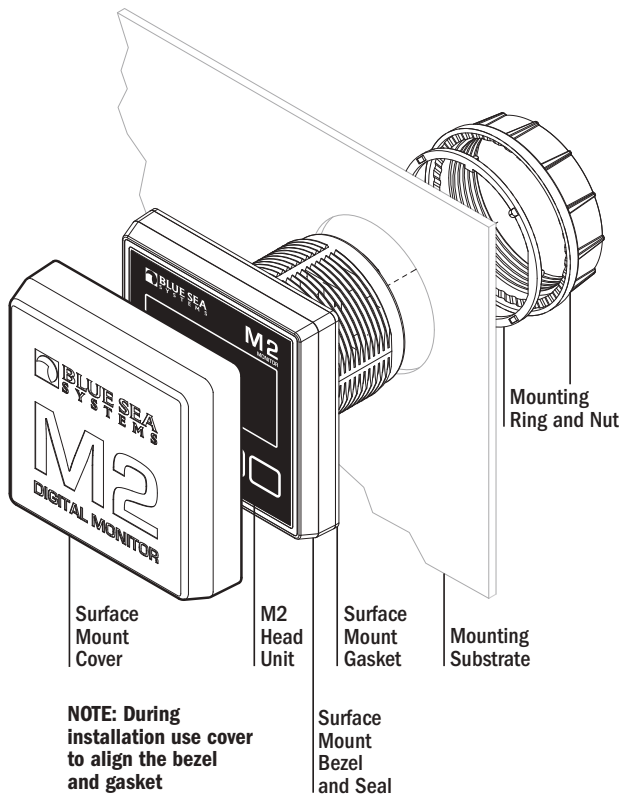

## 360 Panel Mount PN 1525

**STEP 1**  
Use 1/4" Mounting Screws

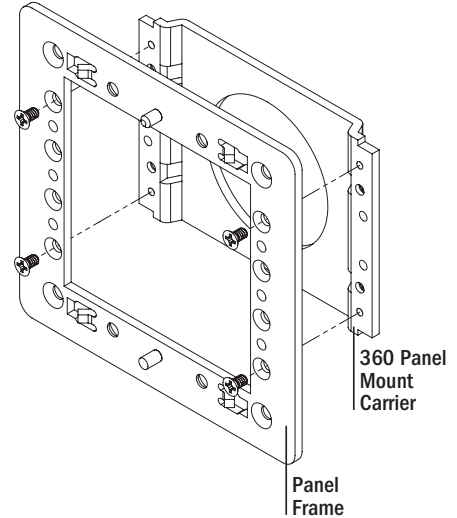

**STEP 2**

Snap header and footer into mounting clips and post. Snap the mounting bezel into place with the flat edge up.

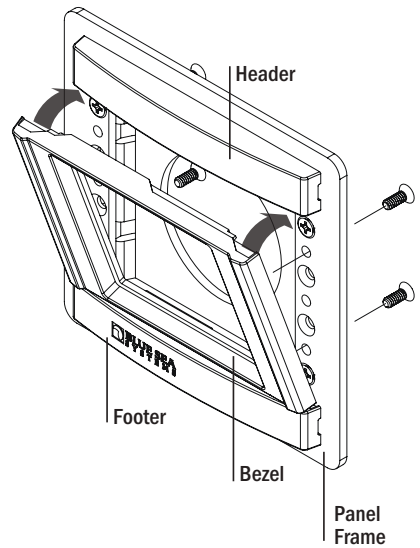

**STEP 3**

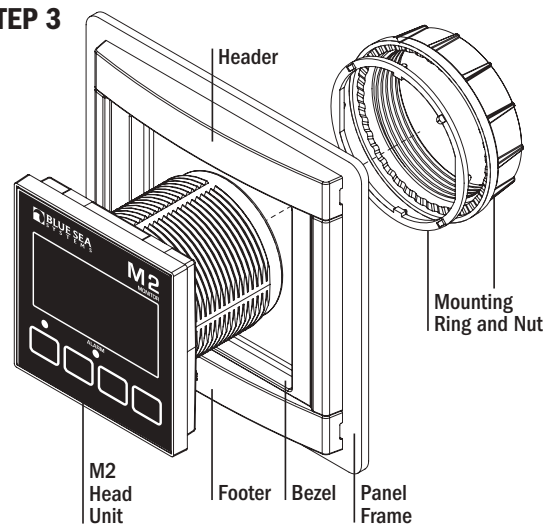

## AC Functions (1836, 1837, 1838)

**1836** AC Ammeter measures the current draw of up to two sources or legs.

**1837** AC Voltmeter measures the voltages of up to two sources or legs.

**1838** AC Multimeter measures the voltages and current draws of up to two sources or legs.

## Connections

**IMPORTANT!** The Sensing Description section of this manual gives important details to the location of sensors in the AC and DC electrical systems of the boat. Improper location and configuration of sensors can result in erroneous readings and possible damage to components.

## Pinout Tables

### 1836 Connector Pin Assignment Table

8 Pin Connector*	Function
1 <i>Required Connection</i>	DC Negative
2 <i>Required Connection</i>	DC Positive
3	Relay DC Out to Load
4	Relay DC +
5	AC 1 Current Transformer -
6	AC 1 Current Transformer +
7	AC 2 Current Transformer -
8	AC 2 Current Transformer +
USB	Micro USB Port

\*The 8 pin low voltage connector supports wire sizes from 16-26 AWG

### 1837 Connector Pin Assignment Table

4 Pin Connector*	Function
1	AC Voltage 1 - HOT
2	AC Voltage 1 - NEUTRAL
3	AC Voltage 2 - NEUTRAL
4	AC Voltage 2 - HOT
8 Pin Connector**	Function
1 <i>Required Connection</i>	DC Negative
2 <i>Required Connection</i>	DC Positive
3	Relay DC Out to Load
4	Relay DC +
5	No Connection
6	No Connection
7	No Connection
8	No Connection
USB	Micro USB Port

\*The 4 pin high voltage connector supports wire sizes from 12-24 AWG

\*\*The 8 pin low voltage connector supports wire sizes from 16-26 AWG

### 1838 Connector Pin Assignment Table

4 Pin Connector*	Function
1	AC Voltage 1 - HOT
2	AC Voltage 1 - NEUTRAL
3	AC Voltage 2 - NEUTRAL
4	AC Voltage 2 - HOT
8 Pin Connector**	Function
1 <i>Required Connection</i>	DC Negative
2 <i>Required Connection</i>	DC Positive
3	Relay DC Out to Load
4	Relay DC +
5	AC 1 Current Transformer -
6	AC 1 Current Transformer +
7	AC 2 Current Transformer -
8	AC 2 Current Transformer +
USB	Micro USB Port

\*The 4 pin high voltage connector supports wire sizes from 12-24 AWG

\*\*The 8 pin low voltage connector supports wire sizes from 16-26 AWG

## Meter Power Supply Connections

All meters must have pins 1 (DC Neg.) and 2 (DC Pos.) connected. These pins are used to provide power to the meter. Connect pin 1 to ground and pin 2 to a 12V to 48V power source. Note on some DC meters pin 2 is also used to monitor additional voltages.

## AC Connections (1836, 1837, 1838)

### AC Current

In most cases, the AC Current Transformer should be located on the main AC line wire before any other devices. See <http://blueseas.com/viewre-source/86> for more information on AC Current Transformer location.

The Current Transformer does not indicate polarity. The leads should be twisted to reduce the effects of interference from other electrical circuits.

### AC Voltage

The AC supply HOT ( Line, or "Ungrounded Conductor") connection should be protected with a fast acting fuse of 0.25A to 0.5A to protect against shorts.

# Detailed Wiring

## 1836 AC Ammeter

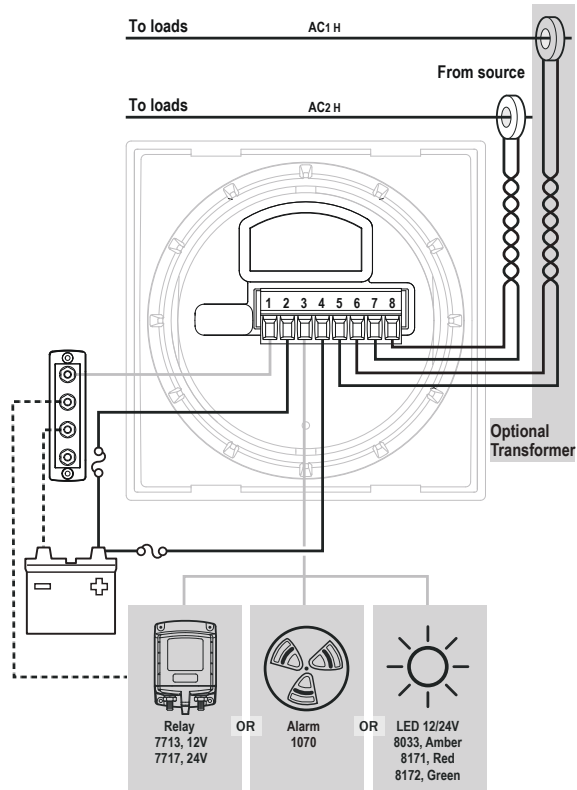

## 1838 AC Multimeter (North American 120V / European 230V)

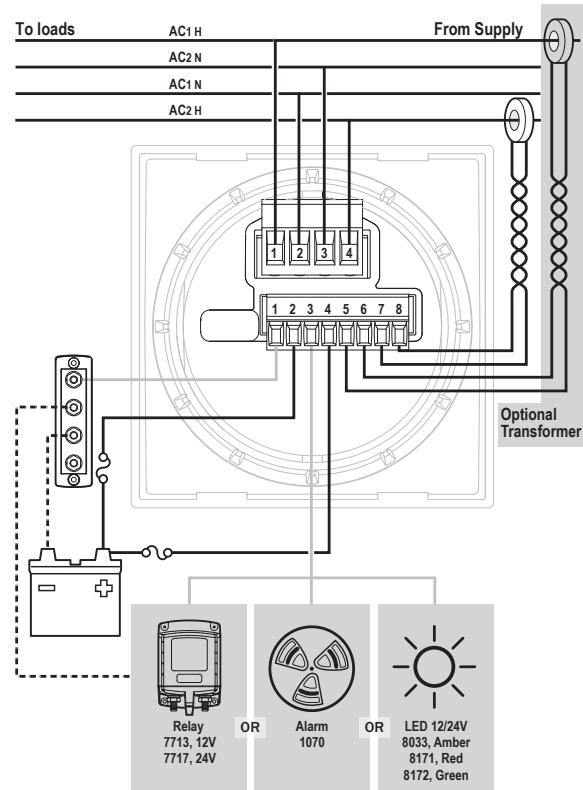

## 1837 AC Voltmeter

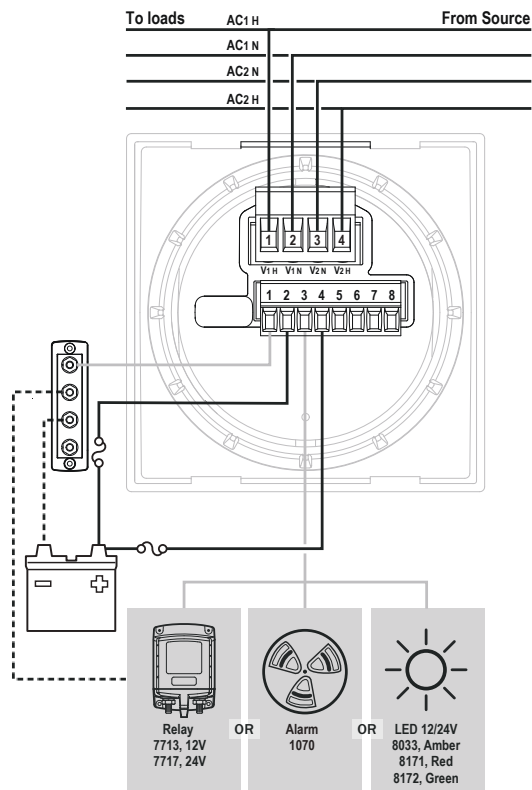

## Detailed Wiring continued

### 1838 AC Multimeter (North American Split Phase 120V / 240V)

To monitor a split/phase system, place the AC 1 & 2 Voltage Hot ("LINE", or "Ungrounded Conductors") and Neutral ("Grounded Conductor") connections on the LOAD side of the transfer switch as indicated in the diagram.

**NOTE:** AC 1 Voltage Neutral and AC 2 Voltage Neutral are tied together.

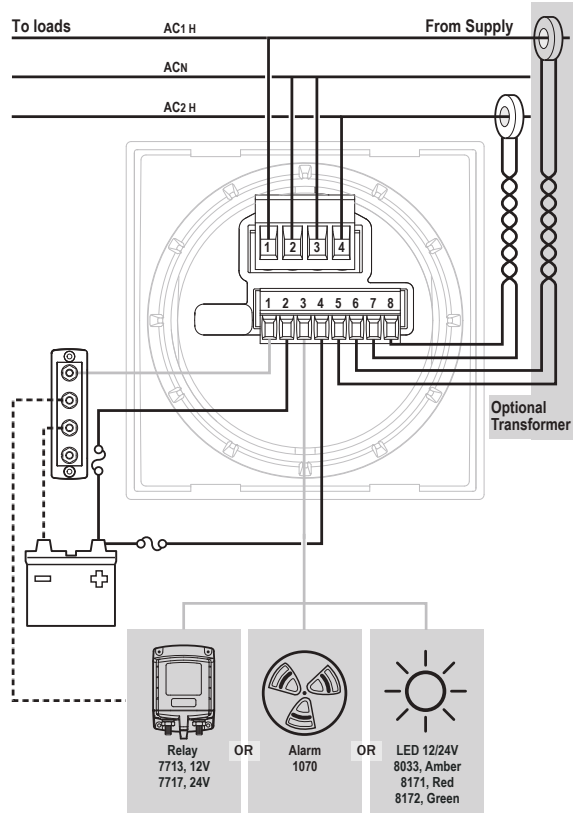

For more information regarding Current Transformer placement in 120/240 Volt AC Systems, refer to the following article:  
[https://www.blueseas.com/support/articles/AC\\_Circuits/86/Current\\_Flow\\_in\\_120\\_240\\_Volt\\_AC\\_Systems](https://www.blueseas.com/support/articles/AC_Circuits/86/Current_Flow_in_120_240_Volt_AC_Systems)

## M2 Relay Connections

M2 Meters contains an internal MOSFET relay that can drive external DC loads up to 0.5A. The input is protected with a thermally activated auto-resetting fuse that will protect against shorts. In addition, an inline fuse rated at 5A should be used to protect against shorts. In typical applications, a power source is connected to the Relay+ pin and a load is connected to the Relay Out to Load connection. In the P/Ns 1830, 1833, and 1834 meters, the Relay+ connection can also be used to monitor a voltage.

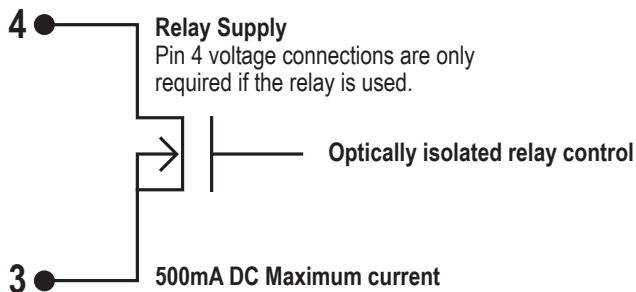

## External LED

An external LED such PN 8171 can be connected to the Relay Output terminal. If the system is going to operate at more than 24V nominal, an additional 4K Ohms of resistance should be placed in-line with the LED.

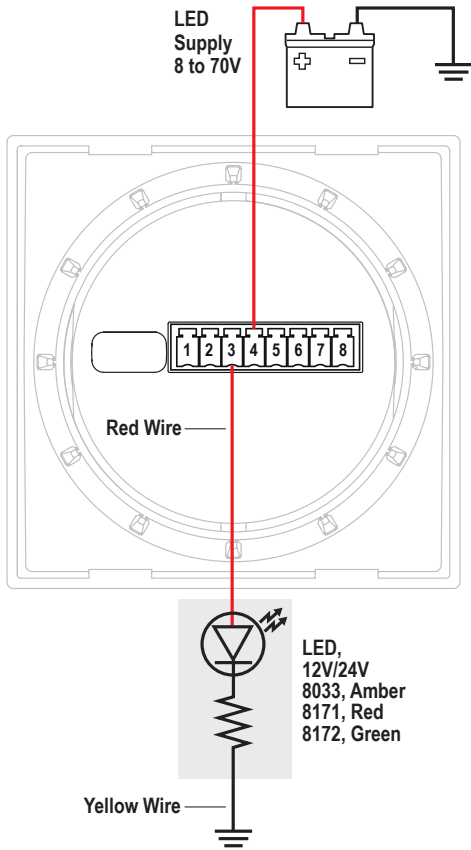

## External Alarm (1070 Floyd Bell Turbo)

The Relay+ terminal can support an external audible alarm. Such as the Floyd Bell Turbo Alarm (PN 1070).

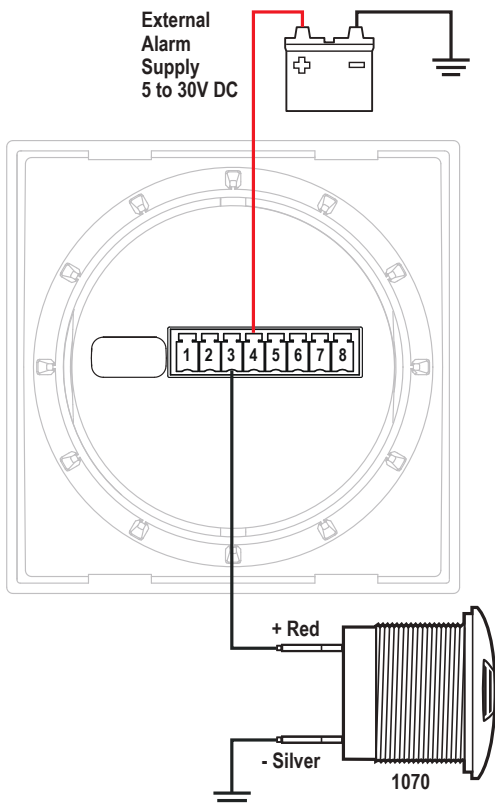

## External Relay

If you need to switch more than 0.5 A, you can use an external relay such as PN 7713, 12V or PN 7717, 24V Remote Battery Switch. Connect the Relay+ terminal to the red control wire. Activating the internal relay will also activate PN 7713.

**NOTE:** 9012, 7700, 7701, 7702, & 7703 Remote Battery Switches are not compatible with the internal relay.

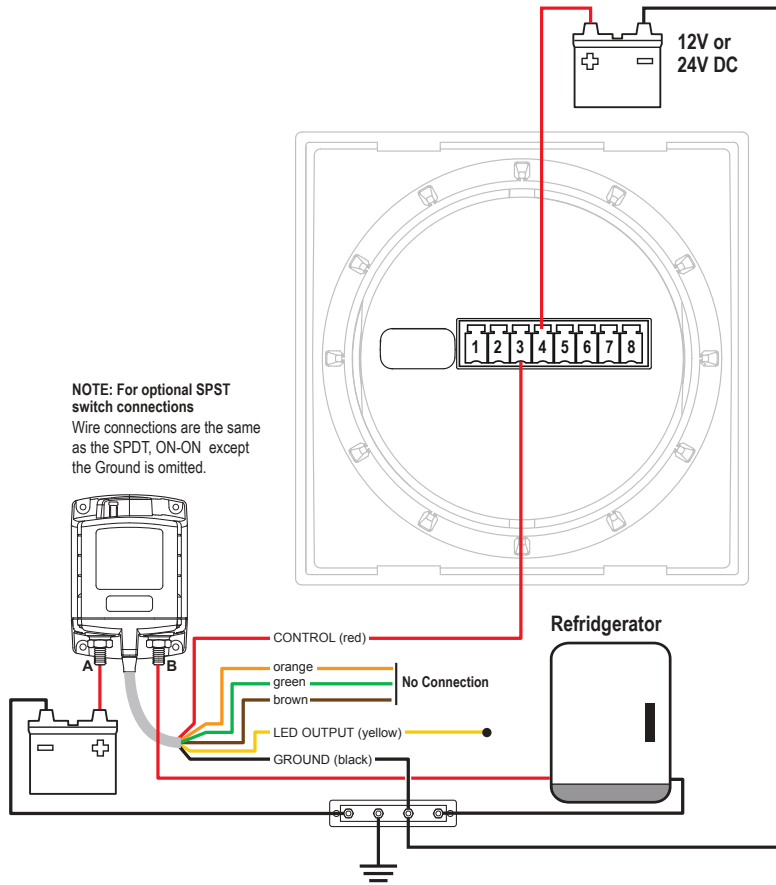



# Getting Started

## Example Screens From PN 1838 AC Multimeter

When an M2 Meter is initially powered up, it will display the Blue Sea Systems Logo, its serial number and its Software revision. After a couple of seconds, the unit will display a high-level System Summary screen.

Shore 1 AC	Shore 2 AC
119 V	120 V
4.5 A	5.5 A
60 Hz	61 Hz

Pressing any button will display a temporary pop-up menu. Select an option by pressing the button beneath it. The pop-up menu will disappear after the first button is pressed.

Shore 1	Shore 2
119 V	120 V
4.5 A	5.5 A
Next ↑	↓ Menu

The menu system is a two dimensional matrix. Pressing the the **UP ↑** or **DOWN ↓** arrow buttons will transition the display between the System Summary screen which displays summary information for each of the “voltage” or “current” channels.

Press the **Next** button to display more detailed information about an input channel or to show a single parameter, such as “voltage” in the display (see example below).

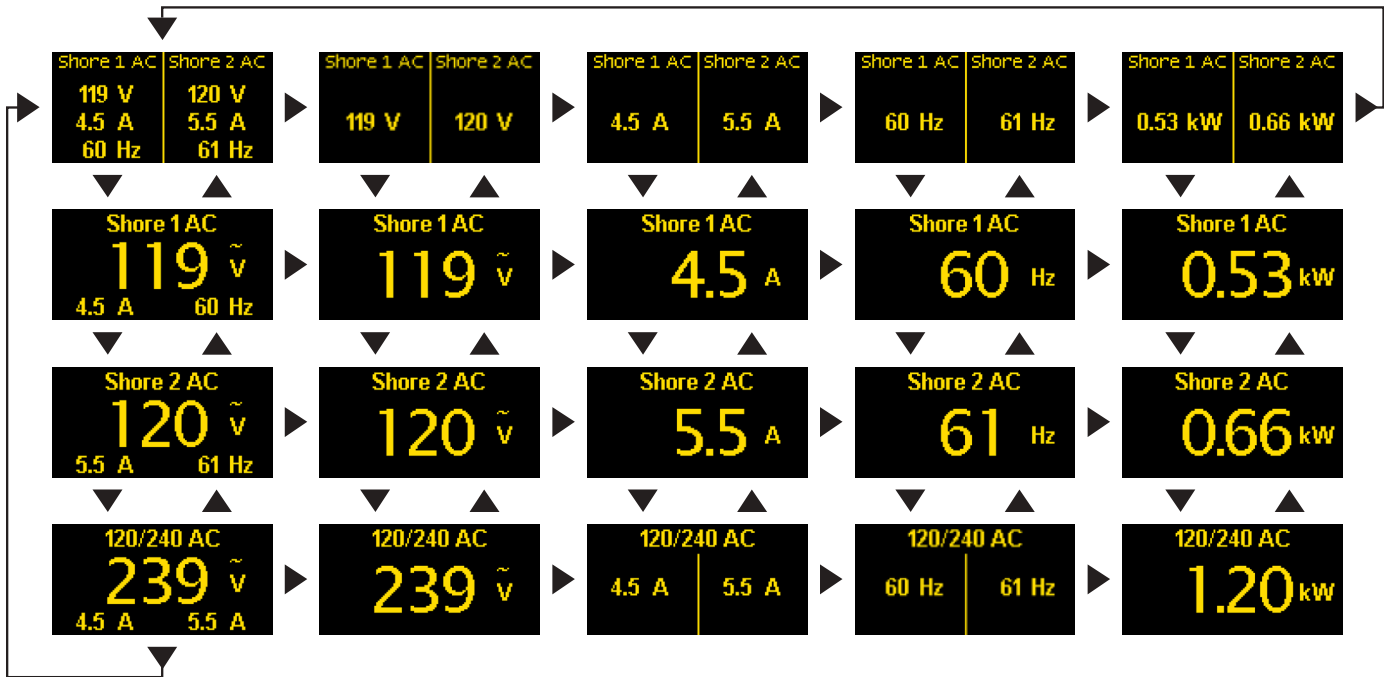

Press the **Menu** button to bring up a shortcut menu to for additional summary screens as well as to access the Setup menus. Press the **UP ↑** and **DOWN ↓** arrow buttons to move the cursor over the options and press the **Select** button to see a selected display. To return to the previous display, press the **Back** button.

Summary	Frequency
Volts	Power
Amps	Setup
Back ↑	↓ Select

## Configuring the Meter

Meter settings can be configured from the Setup menu. This menu can be accessed by pressing the **Menu** button and then scrolling to and selecting **Setup**. Press the **UP** ↑ and **DOWN** ↓ arrow buttons to move the cursor. The different setup options are described below.



### Alarm Setup & Control

The meter's alarm can be set to trigger under certain conditions of voltage, current, or frequency. Alarms can be set from the Alarm Setup menu. To get there, first navigate to the Setup menu. Then scroll to Alarm Setup and press the button under Select.

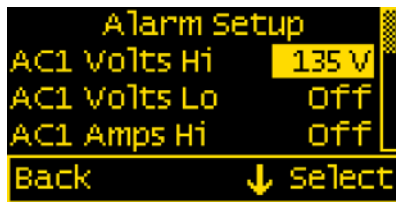

### Setting Alarms

The M2 Meter family provides monitoring capability of input channels. The meter can monitor Voltage, Current, and Frequency. Alarms are triggered if a channel is above or below a certain user selected threshold value. (Note: not every meter supports every alarm)

The following example indicates how to setup an over voltage Alarm.

- 1.Go to the Alarm Setup menu.
- 2.Scroll to the desired input channel (i.e, AC1 Volts Hi).
- 3.Press the **Select** button and the cursor should start blinking.
- 4.Set the voltage threshold using the ← and → buttons. (Holding down the buttons allows faster selection)
- 5.Press the Enter button to save the change or the Cancel button to cancel any change.

**NOTE:** A low voltage threshold cannot be set above a high voltage threshold. Likewise, a high voltage threshold cannot be set below the low voltage threshold. The meter will automatically increase or decrease the voltage thresholds to enforce this.

In the above example, an alarm will set anytime AC1 voltage is greater than or equal to 135V.

## Voltage Alarm

Voltage alarms can be set for high (Hi) or low (Lo) voltage conditions.

## Current Alarm

The current alarm can only be set for over current conditions.

## Frequency Alarm

The frequency alarm is only available on AC meters and indicates that the AC frequency is out of range. The alarm is only valid if the input AC voltage is greater than 40 Volts.

## AC Alarm Dly (Delay)

An alarm delay can be specified so that alarms don't immediately trigger. The hold off timer operates as a count-up/count-down timer. When the measurement exceeds the alarm value then the timer will start counting up until it reaches the delay time. When it reaches the delay timer, an alarm will sound. If the alarm condition goes away before the delay timer has been met, then the timer will count down until the timer is zero again. For example, if the Alarm Delay is set for 5 minutes and an alarm condition is active for 4 minutes and then inactive for 1 minutes then if the alarm condition is active again, the alarm will sound in 2 minutes (5 minutes - 4 minutes + 1 minute). Note that there is only one delay per channel.

## Clearing Alarms

When an alarm occurs, the buzzer will sound, the red ALARM LED will light, and the screen will display which alarm was triggered, the Alarm set point and the current value. Pressing any button silences the buzzer and another button press returns to the previous display.

Until the cause of the alarm is resolved, the ALARM LED will remain on and the channel that triggered the alarm (Voltage, Current, or Frequency) will blink.

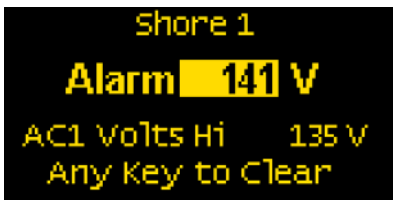

## Viewing Alarms Status

For any active alarm, the parameter will flash if it is displayed. To view a complete list of active alarms, press **Menu>Setup>Alarm Setup**. Any active alarm will flash. You may have to scroll through the menu to see all of the alarms.

## Relay Setup & Control

M2 Meters provide an option to control an external relay. The M2 can trigger the relay based on Voltage, Current, or Frequency.

These relay options can be set from the Relay Setup menu. To get there, first navigate to the Setup menu. Then scroll to Relay Setup and press the Select button.

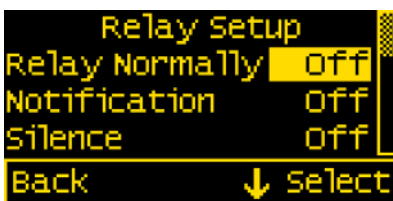

## Relay Normally On/Off

This setting sets the normal operating state of the connected relay. The options are ON or OFF where ON means the relay is on (contacts closed) in normal operation and OFF means it is normally off (open contacts). Scroll to Relay Normally, press **Select** (selection will flash), then press the **LEFT ←** or **RIGHT →** arrow buttons to change the setting. Press **Enter** to save your selection. Press **Cancel** to cancel a change.

## Notification

The Notification setting controls whether or not a notification is displayed when a relay is activated. Notifications will show which relay threshold was surpassed and for which channel. Scroll to Notification and press **Select** to change the setting. Press the **LEFT** ← or **RIGHT** → arrow buttons to choose either ON or OFF. ON will display notifications and OFF will not. Use this option if you don't want to be notified that the relay is activating. Press **Enter** to save the setting or **Cancel** to cancel a change.

## Silence Relay

Turn this option on if you want the relay to de-activate after the user presses a key on the display. The key press will only de-activate the relay and will not engage any functions on the meter. For example, this option could be used to silence an external buzzer. Scroll to Silence and press **Select** to change the setting. Press the **LEFT** ← or **RIGHT** → arrow buttons to choose either ON or OFF. Press **Enter** to save the setting or **Cancel** to cancel any change.

## AC Relay Dly (Delay)

An alarm delay can be specified so that alarms don't immediately trigger.

## Setting Input Thresholds

Settings for each channel's high and low voltage thresholds are provided. The connected relay's normal operating state will toggle (change state) if these thresholds are met. For both high and low thresholds, the activation and deactivation voltages are different to prevent the relay from rapidly toggling (cycling on and off). Each channel has Hi ON and Hi OFF settings and Lo ON and Lo OFF settings.

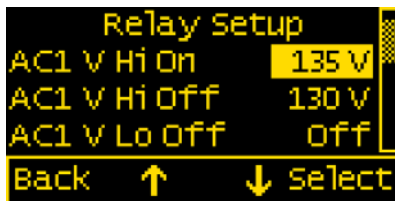

Relay Setup Screen with Relay Normally = Off (Open)



Relay Setup Screen with Relay Normal = On (Closed)

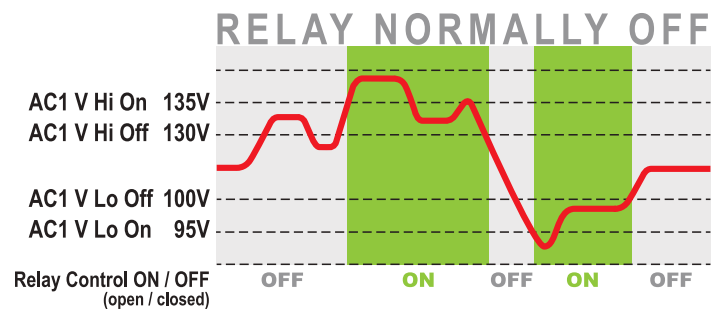
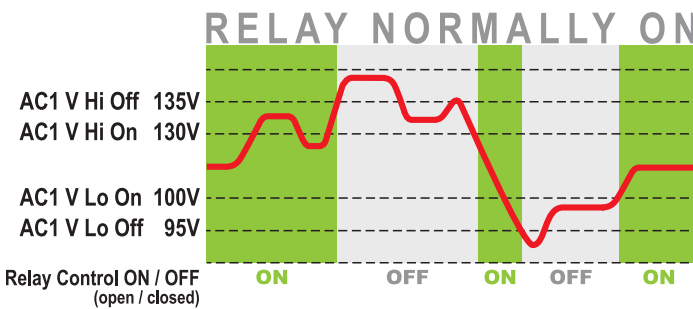

## LEGEND

AC 1 Voltage —

**Example.** If the relay is Normally On (closed) and is connected to AC1, then it will open at the User input threshold value for AC1 V Hi Off (135 V). To close again, the voltage must drop below the User's input value for AC1 V Hi On (130 V). Similarly, the relay will open at the User input for AC1 V Lo Off. The voltage must meet the User input for AC1 V Lo On to close the relay.

To change one of the settings, scroll to desired setting and press **Select**. Press the **LEFT** ← or **RIGHT** → arrow buttons to change the Voltage value and then press **Enter** to save the setting. Press **Cancel** to cancel the change.

**NOTE:** Lower threshold settings cannot be set above higher voltage threshold settings. Similarly, higher voltage thresholds cannot be set below lower voltage thresholds. The meter will automatically increase or decrease the voltage thresholds to enforce this.

## Clearing Relay Notification

If the Notification option is set to ON then any time the relay is opened (Normally Off) or closed (Normally On). A message will be displayed on the main screen. Pressing a key will clear this notification. If Silence is set to ON then the relay will be opened (Normally Off) or closed (Normally On).

## Viewing Relay Status

For any active alarm, the parameter will flash if it is displayed. To view a complete list of active alarms, press **Menu>Setup>Relay Setup**. Any active relay will flash.

## Display Setup

The meter display settings can be accessed from the Display Setup menu. From the setup screen, scroll to Display Setup and press the **Select** button.

The different display settings are described below. To change a setting, press **Enter** and press the **LEFT ←** or **RIGHT →** arrow buttons to view the available setting options. Press **Enter** to save the setting. Press **Cancel** to cancel a change.

### Brightness

This setting is for adjusting the brightness of the display. The value is a percentage where 0 % is dimmest and 100 % is brightest.

### Sleep Timer

Following a certain period of inactivity, the meter will enter a sleep mode and will turn off the display. Any button may be pressed to exit the sleep mode and restore the display. The Sleep Timer sets the number of minutes from 0 to 600 before entering sleep mode. This feature will be disabled by changing the setting to OFF.

### Dim Timer

In addition to sleep mode, the meter can also dim its display after a period of inactivity. The duration of delay in minutes from 0 to 600 can be adjusted with this setting. This feature will be disabled by changing the setting to OFF. By continuously pressing the **LEFT ←** button the meter can be placed in AUTO dim mode. In this mode the meter will automatically dim after two minutes when the ambient light is low (night mode). When the light comes back on, the meter will revert to its normal brightness.

### Demo Mode

With Demo Mode ON, the meter displays factory programmed values for the voltages, current, and frequency, depending on meter PN. Changing the setting to OFF returns the meter to display actual measured values. This mode is typically used for commercial or promotional purposes. Note: Alarms and Relay settings will still respond to the actual settings and not the Demo settings. To enter Demo Mode, press **Menu>Setup>Display Setup>Demo Mode**. Press the **LEFT ←** or **RIGHT →** arrow buttons to toggle Demo Mode ON or OFF.

## Changing System Labels

The M2 allows the user to change the labels that are displayed above each channel. Each channel can have a maximum of 16 characters however in the summary screens only the first 11 or 12 characters of the channel label are displayed.

## Changing Label Names

To change the name of a channel, follow the instructions below:

1. Navigate to the setup menu for the desired channel (such as AC1 Setup). **Menu->Setup->AC1 Setup**
2. In the channel setup menu, move the cursor to channel name to be changed (indicated by the >> symbol)
3. Press **Select** to enter the name editing mode.
4. Use the **LEFT ←** and **RIGHT →** arrow buttons to move the cursor over the characters.
5. When the cursor is over a character, press **Enter** to edit that character. The cursor will start blinking.
6. Use the **UP ↑** and **DOWN ↓** arrow buttons to select a new character and press **Ok** to set that character.
7. Once all desired characters have been changed, press the **Cancel** button to exit the name editing mode.

## AC1, AC2, AC1+2 Setup

### Enable

To display the channel and its measurements, change this setting to ON. If enable is OFF, the channel along with its measured values will not be displayed. However, any associated alarm or relay settings are still activate. To de-active the alarm or relay, disable them in the Alarm Setup and Relay Setup menus.

### Toggle A/V

Switch the Current and Voltage display on the channel's Summary Screen. If this option is set to OFF then Voltage will be displayed in the center field. If the option is set to ON Current will be displayed in the center field.

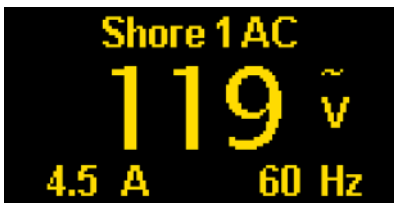

Example: Toggle A/V Set to OFF

### Full Scale Amps

The M2 is shipped with a 150AAC/50mAAC Current Transformer (the ratio is 3000:1). The full scale output is based on transformers with a maximum output value of 50mAAC. A different value transformer can be calculated with the following formula: Full Scale Amps = New Ratio / 20. For example to replace the standard transformer with a 100A/20mA transformer (Note: 20mA = 0.02A):  $(100A / 0.02) / 20 = 250A$ .

### Version Info

The Version Info option in the Setup menu displays the product name, serial number, and software version. This information will be displayed on a screen after scrolling to Version Info and pressing **Select**. Pressing any button will return to the Setup menu.

### Factory Reset

The Factory Reset option in the Setup menu allows the user to restore the meter's factory default settings. First scroll to Factory Reset and press **Select**. Text will appear asking to confirm or cancel the reset request. Press **Yes** to confirm or **No** to cancel the reset.

## Software Upgrade

The meter firmware can be updated in one of two ways. The first option is to use the Software Upgrade option in the Setup menu. The second option is to force the meter into upgrade mode on startup.

Each method involves using a USB memory stick connected to the USB port on the back of the meter. The USB port is a type A/B micro USB port. This port is also known as a Micro USB Host OTG. Available at Best Buy or Amazon: <http://amzn.com/B00J631SU8>

**CAUTION**  Removing power or the USB memory stick during the upgrade process will render the meter inoperable.

Both methods are described below:

### Upgrade via Software Upgrade Option

1. Download a new version from <http://www.blueseas.com/m2firmware>.
2. Copy firmware to a USB Memory Stick. The file name should be image.xxxx.bin., where xxxx is the PN of the meter. i.e., 1836, 1837, etc.
3. Remove USB dust cover plug.
4. Insert memory stick into the USB socket on back of the meter. Note: You may need an adapter dongle to interface between the memory stick and the meter (<http://amzn.com/B00J631SU8>).
5. Select Software Upgrade option.
6. Answer Yes to "Are you sure you want to update the Flash?"
7. The red LED on the M2 will rapidly flash for about 10 seconds.
8. If the upgrade was successful, a message with the new software version will be displayed.
9. If there is an error then a message will be displayed (see error messages below).
10. Remove USB memory stick.
11. Replace USB dust cover with "USB" text right side up.

### Upgrade via Forcing Meter into Upgrade Mode

1. Download a new version from <http://www.blueseas.com/m2firmware>.
2. Copy firmware to a USB Memory Stick. The file name should be image.xxxx.bin., where xxxx is the model number of the meter. i.e., 1836, 1837, etc.
3. Turn off the power to the unit.
4. Remove USB dust cover plug.
5. Insert the memory stick into the USB socket on back of the unit. Note: You may need an adapter dongle to interface between the memory stick and the meter: (<http://amzn.com/B00J631SU8>).
6. While pressing and holding the leftmost and rightmost keys, turn the power to the meter ON.
7. The red LED on the M2 will rapidly flash for about 10 seconds.
8. If the upgrade was successful, a message with the new software version will be displayed.
9. If there is an error then a message will be displayed (see error message below).
10. Remove USB memory stick.
11. Replace USB dust cover with USB label facing up.

### Upgrade Messages

- Flash Successful / SW Version: xxx - Upgrade successful.
- File Not Found - A valid flash image was not found on the meter. The downloaded upgrade filename should be image.xxxx.bin, where xxxx is the model number of the meter. i.e., image.1836.bin, image.1837.bin, etc.
- Corrupted File - The image is not valid or corrupted. Re-download the updated image from [www.blueseas.com](http://www.blueseas.com).
- No USB Device - The USB memory card is not plugged in or the cable is defective.
- Wrong Model Number - The image file is for a different meter. Download a new file from [www.blueseas.com](http://www.blueseas.com).
- Wrong HW Version - The new image file does not support this revision of hardware.



425 Sequoia Drive  
Bellingham, WA 98226 USA

p 360.738.8230  
p 800.222.7617 USA and Canada Customer Service  
f 360.734.4195  
conductor@blueseas.com  
www.blueseas.com