

START HERE!

READ ME FIRST

Don't be a hero and muscle through this installation without reading these fitting instructions first! Improper installation of this gear may void certain aspects of your warranty.

Before you begin, take a moment and open all your Front Runner rack kit boxes and gather the assembly instructions for the various components.

A complete kit will contain:

1. Front Runner Mounting System specific to your vehicle
2. Front Runner Rack Tray or Load Bar Slats

This document will guide you through the assembly of the mounting system and assist you in fitting the roof rack tray or load bars to your specific vehicle.

Please refer to the next page for a list of all the components, quantities and tools required.

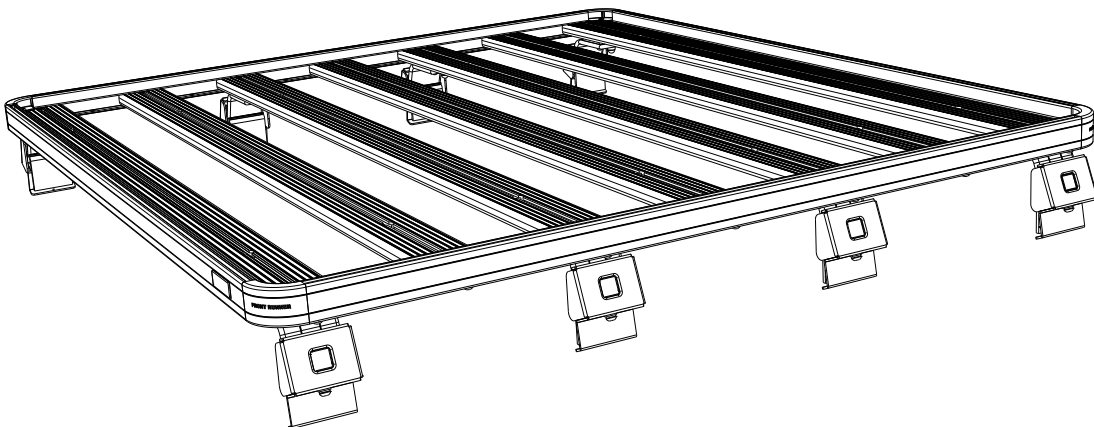

IMPORTANT WARNING! ⚠

IT IS CRITICAL THAT ALL FRONT RUNNER PRODUCTS BE PROPERLY AND SECURELY ASSEMBLED AND ATTACHED TO YOUR VEHICLE. IMPROPER ATTACHMENT COULD RESULT IN AN AUTOMOBILE ACCIDENT, AND COULD CAUSE SERIOUS BODILY INJURY OR DEATH. YOU ARE RESPONSIBLE FOR ASSEMBLING AND SECURING ALL FRONT RUNNER PRODUCTS TO YOUR VEHICLE, CHECKING THE ATTACHMENTS PRIOR TO USE, AND PERIODICALLY INSPECTING THE PRODUCTS FOR ADJUSTMENT, WEAR AND DAMAGE. THEREFORE, YOU MUST READ AND UNDERSTAND ALL OF THE INSTRUCTIONS AND PRECAUTIONS SUPPLIED WITH YOUR FRONT RUNNER PRODUCT PRIOR TO INSTALLATION OR USE. IF YOU DO NOT UNDERSTAND ALL OF THE INSTRUCTIONS AND CAUTIONS, OR IF YOU HAVE NO MECHANICAL EXPERIENCE AND ARE NOT THOROUGHLY FAMILIAR WITH THE INSTALLATION PROCEDURES, YOU SHOULD HAVE THE PRODUCT INSTALLED BY A PROFESSIONAL INSTALLER OR OTHER QUALIFIED PERSONNEL.

NOTE: Front Runner will not be responsible for any damage caused by the failure to install the product according to these instructions.

Please call us if you have any questions about the installation of this product.

1

GET ORGANIZED

IN THE BOX

1	1 X	Slimline II Tray - 1475mm(W) X 1358mm(L)
2	1 X	Wind Deflector- 45mm Lip Wide Pair / 1345mm (W)
3	4 X	Jeep JL / JT Mounting Leg / 170mm (Pair)
4	1 X	Leg Spacer 6mm (Pair)

TOOLS NEEDED



FIGURE 1.1

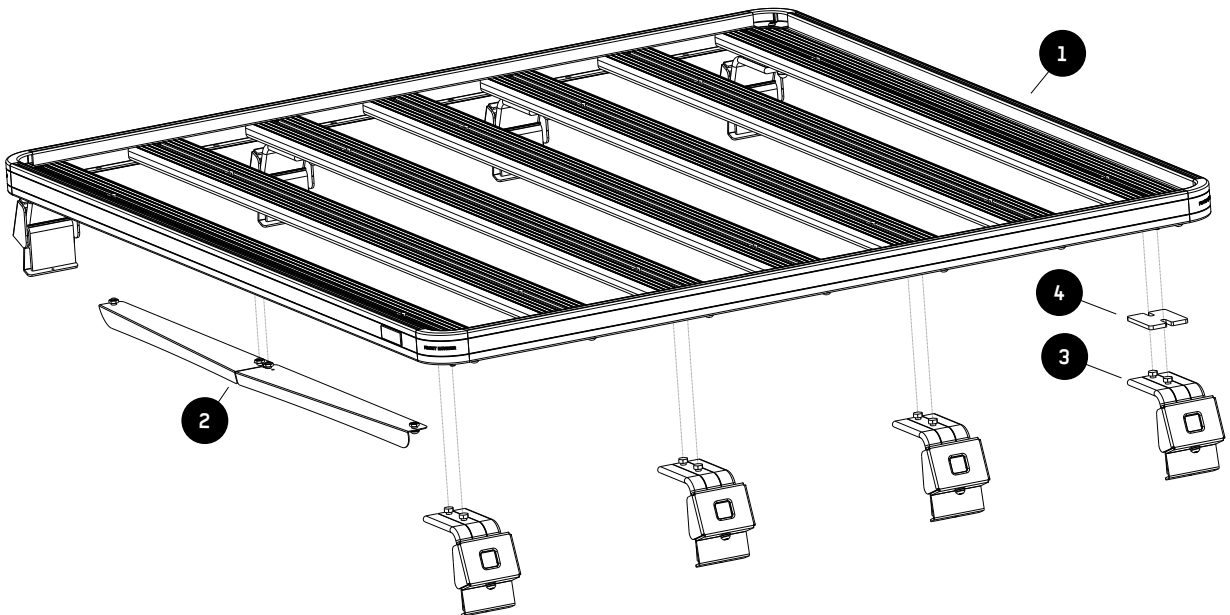

2

FIT AND SECURE

2.1

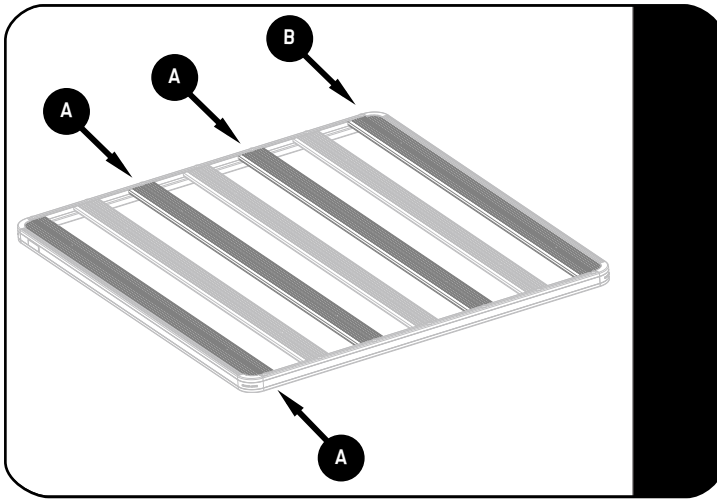

↻ Flip the Tray so that the bottom of the Tray faces up.

A Insert four M8 x 16 Hex Bolts into the machined slots of the slats as shown.

B Insert four M8 x 30 Hex Bolts into the machined slots of the slats as shown.

Before continuing, ensure that your wind deflector is fitted according to Fitment guide WDST006.

2.2

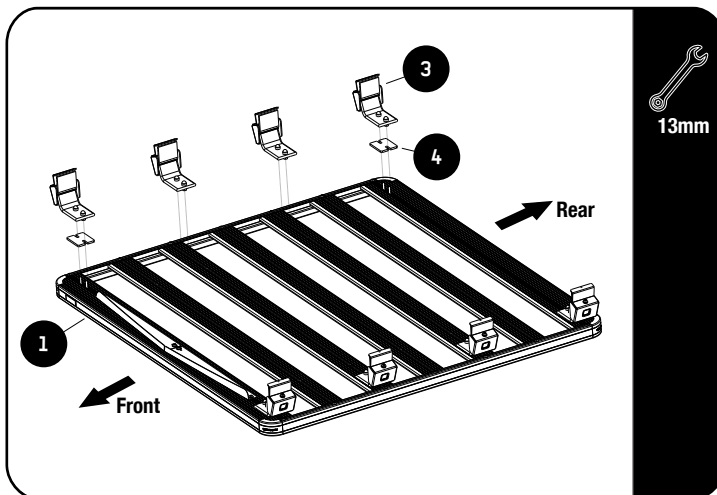

↻ Loosely assemble the Legs & Spacers (Items 1, 3 & 4) as shown, slats indicated in 2.2 using M8 Flat Washers and M8 Nyloc Nuts included in the Leg sets.

2.3

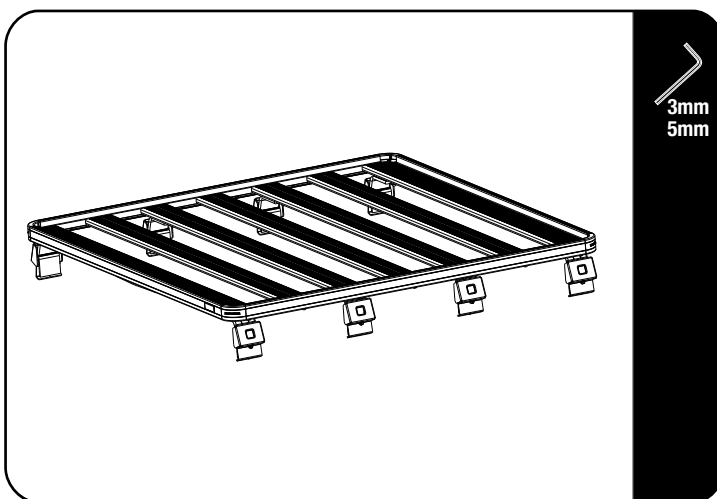

↻ Refer to LASSUNI fitment guide.

3

FIT AND SECURE

3.2



Place your Tray on the vehicle positioning all the feet so that they rest on the gutters.

Position the rack so that the LH and RH rear Legs measures 10mm from the rear of the gutter. Fully tighten all the M8 x 30 Button Head Bolt to secure the Legs to the gutter.



Tightening Torque 10Nm / 7.376 ft lbs



Make sure there is no movement on the rack after fully tightening all the fasteners.

WARNING

Load to be distributed evenly across the rack. Refer to owners manual for roof load limitations.

3.3

Center the rack and tighten fully. Finish off by placing M8 Nut Caps over the M8 Nyloc Nuts.



4

INSTALL OTHER VEHICLE AND RACK ACCESSORIES

Now's the time to visit your favorite Front Runner Dealer in person or online.

IMPORTANT!

FRONT RUNNER RACK KITS OFTEN HAVE A HIGHER LOAD RATING THAN THE VEHICLES THEY ARE MOUNTED TO. PLEASE REFER TO YOUR SPECIFIC VEHICLE MANUFACTURER FOR A RECOMMENDED ROOF RATING. FRONT RUNNER CANNOT BE RESPONSIBLE FOR IMPROPER LOADING BEYOND THE VEHICLE MANUFACTURER'S STATED LOAD CAPACITY.

Be sure to tag us. We love to see our gear in action! #FrontRunnerOutfitters #BornToRoam

Share your adventures on: