

MPPT solar charger manual

BlueSolar MPPT 150/35 & 150/45

Table of Contents

1. Safety precautions	1
1.1. General safety precautions	1
1.2. Wiring safety precautions	1
2. Introduction	3
2.1. Battery voltage, PV voltage and current rating	3
3. Features	4
3.1. Automatic battery voltage detection	4
3.2. Outstanding MPPT algorithm	4
3.3. Outstanding conversion efficiency	4
3.4. Extensive electronic protection	4
3.5. VictronConnect App	4
3.6. Display	5
3.7. VE.Direct port	6
3.8. Battery charging	6
3.8.1. Adaptive 3-stage battery charging	6
3.8.2. Flexible charge algorithm	6
3.8.3. Equalization charging	6
3.9. Temperature sensing	7
3.9.1. Internal temperature sensor	7
3.9.2. External temperature and voltage sensor	7
3.10. Voltage sensing	8
3.11. Remote on/off	8
3.12. WireBox	8
4. Installation	9
4.1. Mounting	9
4.2. Battery	9
4.3. PV array	9
4.4. Grounding	10
4.5. Electrical connections	11
4.6. Connect the MPPT Control display	11
5. Configuration and settings	13
5.1. How to change settings	13
5.1.1. Settings via the VictronConnect App	13
5.1.2. Settings via the rotary switch	13
5.1.3. Settings via MPPT Control display	15
5.2. All settings explained	15
5.2.1. Battery settings	16
5.2.2. Load output settings	21
5.2.3. Streetlight settings	22
5.2.4. TX port settings	25
5.2.5. RX port settings	26
5.3. Updating firmware	27
5.4. VE.Smart network	28
5.4.1. VE.Smart network setup	28
6. Operation	31
6.1. Start up	31
6.2. Battery charging	31
6.3. Automatic equalization	32
6.4. Lithium batteries	32
6.5. Shutdown and restart procedure	32
6.6. Maintenance procedure	33
7. Monitoring	34
7.1. LED indications	34
7.2. Error codes	35
7.3. Monitoring via the VictronConnect App	35

7.3.1. VictronConnect status screen	35
7.3.2. VictronConnect history screen	36
7.3.3. VictronConnect error reporting	37
7.4. Monitoring via a GX device and VRM	37
8. Warranty	38
9. Troubleshooting and Support	39
9.1. The controller is not operational	39
9.1.1. Visual check	39
9.1.2. Battery supply check	39
9.2. Batteries are not charged	40
9.2.1. Reverse battery polarity	40
9.2.2. Reverse PV polarity	41
9.2.3. Battery full	41
9.2.4. The charger is disabled	41
9.2.5. PV voltage too low	41
9.2.6. Battery voltage setting too low	42
9.2.7. Controlled by an external device	43
9.2.8. Battery supply issue	43
9.2.9. PV voltage too high	44
9.3. Batteries are undercharged	45
9.3.1. Too much DC load	45
9.3.2. Battery charge voltages are too low	45
9.3.3. The battery is almost full	45
9.3.4. Battery cable voltage drop	45
9.3.5. Temperature difference between solar charger and battery	46
9.3.6. Insufficient solar	46
9.3.7. Wrong temperature compensation setting	47
9.3.8. Battery charge current too low	47
9.4. Batteries are overcharged	47
9.4.1. Battery voltage setting too high	47
9.4.2. Battery charge voltages too high	48
9.4.3. Battery unable to deal with equalization	48
9.4.4. Battery old or faulty	48
9.5. Solar issues	49
9.5.1. PV reverse current too high	49
9.5.2. PV yield less than expected	49
9.5.3. Full rated output not reached	50
9.5.4. Max PV output power relates to battery voltage	50
9.5.5. Mixed PV panel types	51
9.5.6. PV connections burned or melted	51
9.5.7. MC4 connectors wrongly connected	51
9.5.8. Optimisers cannot be used	51
9.5.9. Earth fault detection missing	51
9.5.10. Ground current	51
9.6. Communication issues	52
9.6.1. VictronConnect issues	52
9.6.2. VE.Direct port communication issues	52
9.6.3. VE.Smart communication issues	52
9.6.4. Bluetooth issues	52
9.7. Settings or firmware issues	53
9.7.1. Incorrect settings	53
9.7.2. Firmware issues	53
9.7.3. Interrupted firmware update	54
9.8. Operation issues	54
9.8.1. Unable to operate as a power supply	54
9.8.2. Unable to operate as a DC to DC charger	54
10. Technical specifications	55
10.1. Specifications 150/35 and 150/45	55
11. Appendix	56
11.1. Dimensions 100/35 and 150/45	56
11.2. Charger error code overview	57

1. Safety precautions

1.1. General safety precautions



- Read this manual carefully. It contains important instructions that need to be followed during installation, operation and maintenance.
- Save these instructions for future reference on operation and maintenance



- Danger of battery explosion from sparking
- Danger of electric shock
- Install the product in a heatproof environment. Ensure therefore that there are no chemicals, plastic parts, curtains or other textiles, etc. in the immediate vicinity of the equipment.
- The product is not allowed to be mounted in a user accessible area.
- Ensure that the equipment is used under the correct operating conditions. Never operate it in a wet environment.
- Never use the product at sites where gas or dust explosions could occur.
- Ensure that there is always sufficient free space around the product for ventilation.
- Refer to the specifications provided by the manufacturer of the battery to ensure that the battery is suitable for use with this product. The battery manufacturer's safety instructions should always be observed.
- Protect the solar modules from incident light during installation, e.g. cover them.
- Never touch uninsulated cable ends.
- Use only insulated tools.
- This product is designed and tested in accordance with international standards. The equipment should be used for the designated application only.
- Connections must always be made in the sequence described in the [Installation \[9\]](#) chapter of this manual.
- The installer of the product must provide a means for cable strain relief to prevent the transmission of stress to the connections.
- In addition to this manual, the system operation or service manual must include a battery maintenance manual applicable to the type of batteries used.

1.2. Wiring safety precautions



- Use flexible multi-stranded copper cable for the battery and PV connections.
- The diameter of the individual strand of the cable used should not exceed 0.4mm (0.016 inch) or have a surface area exceeding 0.125mm² (AWG26).
- The maximum operating temperature is 90°C (194°F).
-
- A 25mm² cable, for example, should have at least 196 strands (class 5 or higher stranding according to VDE 0295, IEC 60228 and BS6360). An AWG2 gauge cable should have at least 259/26 stranding (259 strands of AWG26). Example of suitable cable: class 5 "Tri-rated" cable (it has three approvals: American (UL), Canadian (CSA) and British (BS)).
- In case of thicker strands the contact area will be too small and the resulting high contact resistance will cause severe overheating, eventually resulting in fire. See below figure for examples of what cable to use and not to use.

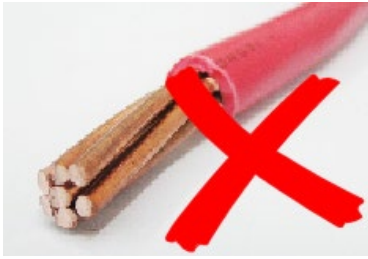

The grounding terminal is located in the wiring compartment and is identified by this symbol:



Ground Symbol

2. Introduction

The Victron Energy BlueSolar charge controller is an ultra fast Maximum Power Point Tracking (MPPT) solar charger with an outstanding conversion efficiency and is suitable for a wide range of battery and PV voltages.

2.1. Battery voltage, PV voltage and current rating

The solar charger can charge a lower nominal-voltage battery from a higher nominal voltage PV array. The controller will automatically adjust to the battery voltage and will charge the battery with a current up to its rated current.

The product name of the solar charger incorporates the maximum PV voltage and the maximum battery charge current.

For example: A 150/45 model has a maximum PV voltage of 150V and can charge the battery with a maximum of 45A.

The table below indicates the maximum PV voltage and maximum battery charge current of the solar chargers that are covered by this manual:

Solar charger model	Maximum PV voltage	Maximum battery charge current	Suitable battery voltages
MPPT 150/35	150V	35A	12, 24, 36 and 48V
MPPT 150/45	150V	45A	12, 24, 36 and 48V

3. Features

3.1. Automatic battery voltage detection

The solar charger automatically detects supported (e.g 12V, or 24V, or 48V) system voltage (battery voltage) on first power up. If a different system voltage is required at a later stage, or if the solar charger is connected to a 36V system, this can be manually configured in the solar charger settings.

3.2. Outstanding MPPT algorithm

Ultra fast MPP tracking

The solar charger contains an ultra fast MPPT controller. This is especially beneficial when the solar light intensity is constantly changing, as is the case during cloudy weather. Because of the ultra fast MPPT controller, 30% more energy is harvested compared to solar chargers with a PWM controller and up to 10% more compared to slower MPPT controllers.

Optimal solar yield

The solar charger has an innovative tracking algorithm. It will always maximize energy harvest by locking to the optimum MPP (Maximum Power Point). If partial shading occurs, two or more maximum power points may be present on the power-voltage curve. Conventional MPPTs tend to lock to a local MPP, which may not be the optimum MPP.

3.3. Outstanding conversion efficiency

The solar charger has an outstanding conversion efficiency. The maximum efficiency exceeds 98%. One of the benefits of the high efficiency is that the solar charger does not have a cooling fan and the maximum output current is guaranteed up to an ambient temperature of 40°C (104°F).

3.4. Extensive electronic protection

The solar charger is protected against over-temperature. The output is fully rated up to an ambient temperature of 40°C (104°F). Should the temperature further increase, the output current will be derated.

The solar charger is equipped with PV reverse polarity protection and PV reverse current protection.

3.5. VictronConnect App

The [VictronConnect App](#) can be used to:

- Monitor the solar charger and view real time solar and battery data.
- Operate solar charger features.
- Access up to 30 days historical data and error history.
- Configure solar charger settings.
- Update firmware.

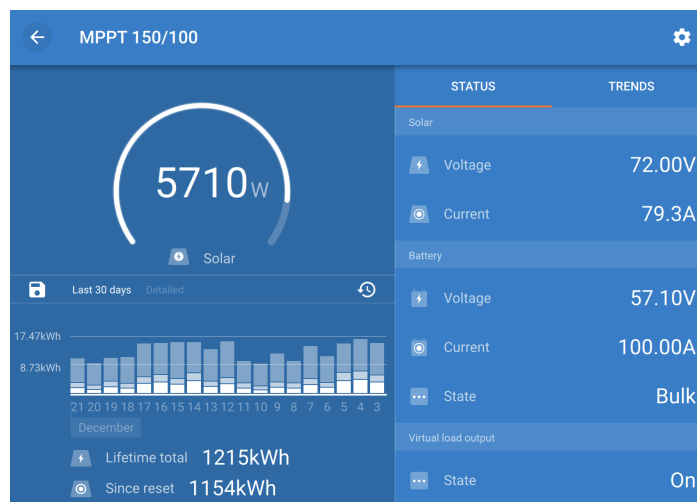

Screenshot of the VictronConnect App, showing real time data and historic data

The VictronConnect App can be downloaded from app stores or from the [Victron Energy downloads page](#). The app is available for the following platforms:

- Android
- Apple iOS (Note that USB is not supported, it is only possible to connect via Bluetooth)
- MacOS
- Windows (Note that Bluetooth is not supported, it is only possible to connect via USB)

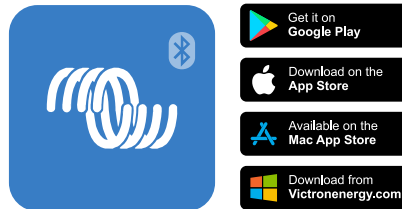

Where to download the VictronConnect App from

The VictronConnect App can connect to the solar charger via the [VE.Direct Bluetooth Smart Dongle](#).

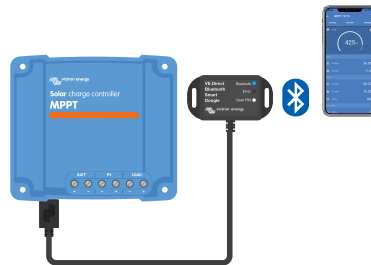

VictronConnect App connection via Bluetooth using a VE.Direct Bluetooth Smart Dongle.

The VictronConnect App can connect to the solar charger via the [VE.Direct USB interface](#).



VictronConnect App connection via USB using a VE.Direct USB interface

The VictronConnect App can connect remotely to the solar charger via a [GX device](#) connected to the same local network or via the internet using the [VRM portal](#).

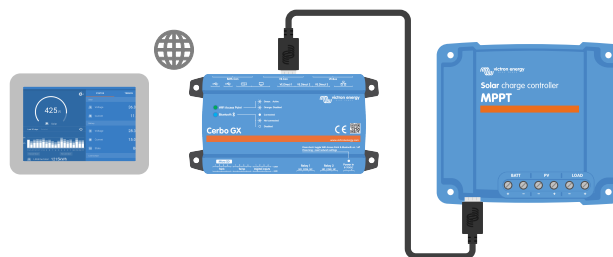

VictronConnect App connection via LAN or the internet (VRM portal) using a GX device (for example a Cerbo GX)

3.6. Display

There are a number of display options:

- The [VictronConnect App](#)
- A [GX device](#)

- The [VRM Portal](#) (GX device or [GlobalLink 520](#) needed)
- The [MPPT Control](#) - an external display that connects to the VE.Direct port (the VE.Direct cable is not included with the MPPT Control)

3.7. VE.Direct port

The VE.Direct port is used to communicate with the solar charger. It can be used for several purposes:

- To connect to a monitoring device, such as a GX device or the GlobalLink.
- To connect with the VictronConnect App.
- For external control.

Special cables or interfaces are needed to connect to this port:

- [VE.Direct cable](#) - used to connect to a GX device or the GlobalLink.
- [VE.Direct to USB interface](#) - used to connect via USB to the VictronConnect App.
- [VE.Direct Bluetooth Smart dongle](#) - used to connect via Bluetooth to the VictronConnect App.
- [VE.Direct TX digital output cable](#) - used for streetlight control or to create a virtual load output.
- [VE.Direct non inverting remote on/off cable](#) - used to remotely switch the solar charger on or off.

3.8. Battery charging

3.8.1. Adaptive 3-stage battery charging

The solar charger is a 3-stage charger. The charge stages are: Bulk – Absorption – Float.

Bulk

During the bulk stage the solar charger delivers the maximum charge current, to rapidly charge the batteries. During this stage the battery voltage will slowly increase. Once the battery voltage has reached the set absorption voltage, the bulk stage stops and the absorption stage will commence.

Absorption

During the absorption stage the solar charger has switched to constant voltage mode. The current flowing to the battery will gradually decrease. Once the current has dropped below 2A (tail current), the absorption stage stops and the float stage will commence.

When only shallow discharges occur the absorption time is kept short. This to prevent overcharging of the battery. But if the battery was deeply discharged, the absorption time is automatically increased, to make sure that the battery is fully recharged.

Float

During the float stage the voltage is reduced and batteries full charged state is maintained.



A storage stage is not needed for a solar charger, unlike is the case for an AC charger, since at night there is no solar power, so battery charging will stop.

3.8.2. Flexible charge algorithm

The VictronConnect App allows selection of 8 pre-set charge algorithms, or alternatively the charge algorithm is fully programmable. The charge voltages, stage duration and the charge current can be customized.

In addition to this, 8 pre-programmed algorithms can be set with a rotary switch.

3.8.3. Equalization charging

Some lead-acid battery types need a periodic equalization charge. During equalization the charge voltage will be increased above the regular charge voltages to achieve cell balancing.

If an equalization charge is required it can be enabled using the VictronConnect App.

3.9. Temperature sensing

Temperature sensing allows for temperature compensated charging. The absorption and float charge voltages are adjusted based on either the battery temperature (accessory needed) or otherwise on the solar charger internal temperature.

Temperature compensated battery charging is needed when charging lead-acid batteries in hot or cold environments.

The temperature compensation can be enabled or disabled in the solar charger settings and the amount of compensation, the compensation coefficient (mV/°C), is adjustable.

3.9.1. Internal temperature sensor

The solar charger has a built-in internal temperature sensor.

The internal temperature is used to set the temperature compensated charge voltages. For this, the internal temperature when the solar charger is "cold" is used. The solar charger is "cold" when there is only little current flowing into the battery. Be aware that this is only an estimation of the ambient and the battery temperature. Should a more accurate battery temperature be needed, consider using an external battery temperature sensor, see chapter [External temperature and voltage sensor \[7\]](#).

[External temperature and voltage sensor \[7\]](#). The temperature compensation range is 6°C to 40°C (39°F to 104°F).

The internal temperature sensor is also used to determine if the solar charger is overheated.

3.9.2. External temperature and voltage sensor

The [Smart Battery Sense](#) is a wireless battery voltage and temperature sensor and can be used with the solar charger. It measures the battery temperature and the battery voltage and sends this via Bluetooth to the solar charger.

The solar charger uses the Smart Battery Sense measurements for:

- Temperature compensated charging using the actual battery temperature, rather than the solar charger's internal temperature. An accurate battery temperature measurement will improve charging efficiency and prolong the life of lead-acid batteries.
- Voltage compensation. The charge voltage is increased to compensate in case there is a voltage drop over the battery cables during high current charging.

The solar charger communicates with the Smart Battery Sense via Bluetooth using a VE.Smart Network. For more detail on the VE.Smart network see the [VE.Smart Networking manual](#).

Alternatively, a VE.Smart Network that measures battery temperature and battery voltage, can also be set up between a solar charger and a [BMV-712 Smart](#) or [SmartShunt](#) battery monitor that has been equipped with a [Temperature sensor for BMV](#), without the need for a Smart Battery Sense.



Note that a VE.Smart Network can only be set up if the solar charger is capable of Bluetooth communication, has Bluetooth enabled or is equipped with a VE.Direct Bluetooth Smart dongle.

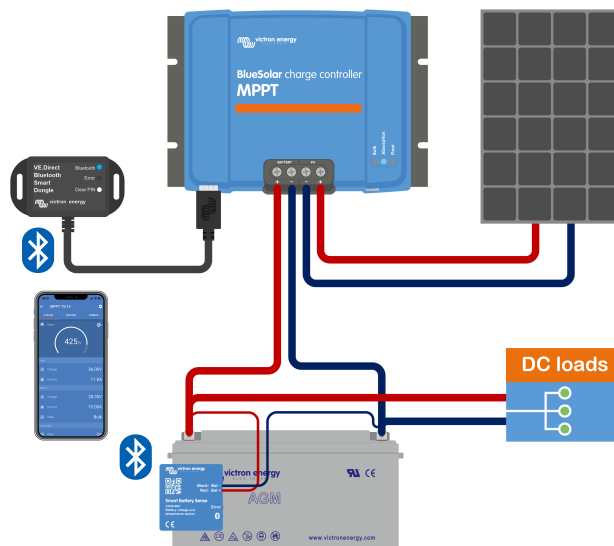

Example of a VE.Smart Network of a Smart Battery Sense and a solar charger

3.10. Voltage sensing

An optional [Smart Battery Sense](#) or [battery monitor](#) measures the battery terminal voltage and sends this via Bluetooth using the [VE.Smart \[28\]](#) network to the solar charger. If the battery voltage is less than the solar charge voltage, the solar charger will increase its charge voltage to compensate for voltage losses.

3.11. Remote on/off

A virtual remote on/off terminal can be created by using the [VE.Direct non inverting remote on/off cable](#).

3.12. WireBox

The optional MPPT WireBox is a plastic cover that can be attached to the bottom of the solar charger. It covers the battery and solar terminals, preventing accidental or inquisitive contact with the battery and PV terminals. It provides an extra level of safety, and is particularly useful if the solar charger is installed in a general access area.

For more information and to find the right MPPT WireBox for your solar charger see the MPPT WireBox product page:

- [MPPT WireBox-Tr](#)

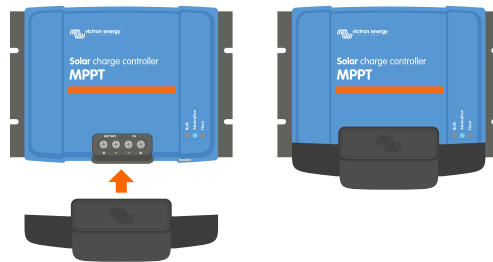

Example of a solar charger with MPPT WireBox

4. Installation



The DC (PV) input is not isolated from the battery circuit. Therefore the PV, battery and control circuit are considered hazardous and should not be user accessible.



For proper temperature compensated battery charging the ambient temperature of the solar charger and the battery must be within 5°C (9°F).



The battery and PV connections must be guarded against inadvertent contact. Install the solar charger in an enclosure or install the optional [WireBox \[8\]](#).

4.1. Mounting

Mount the solar charger vertically on a non-flammable substrate, with the electrical terminals facing downwards.

If the optional MPPT WireBox is used, affix the steel WireBox base to the solar charger before the solar charger is mounted into its final position. For more information see the MPPT WireBox manual.

The [Appendix \[56\]](#) of this manual contains the dimension drawing of the solar charger, this drawing also indicates the mounting holes.

Observe a minimum clearance of 10cm under and above the solar charger for optimal cooling.

Mount the solar charger close to the battery, but never directly above the battery. This to prevent damage to due to gassing of the battery.



Avoid ambient temperature differences of more than 5°C between the solar charger and the battery. These temperature differences can lead to incorrect temperature compensated charging, which can reduce the battery lifetime.

If large temperature differences or extreme ambient temperature conditions are expected use a direct battery temperature sense source like the Smart Battery Sense or a BMV or SmartShunt equipped with a temperature sensor.

4.2. Battery

The battery supply must be protected by a fuse as per below table.

Solar charger type	Minimum battery fuse rating	Maximum battery fuse rating
MPPT 150/35	40A	45A
MPPT 150/45	50A	63A



For Canada the battery fuse must comply with the C22.2 standards.



The battery installation must be done in accordance with the local storage battery rules. For Canada this is the Canadian Electrical Code, Part I.



Use flexible multi stranded copper cable for the battery connections Also see chapter [Wiring safety precautions \[1\]](#).

4.3. PV array

The solar charger can be used with a PV configuration that satisfies both these two conditions:

- The maximum open circuit PV voltage can not exceed 150V
- The nominal PV voltage should be at least 5V higher than the battery voltage.

The PV array can consist of mono- or poly-crystalline panels.

The solar panels are connected in series, in parallel or in series/parallel. See below figure for examples of these configurations.

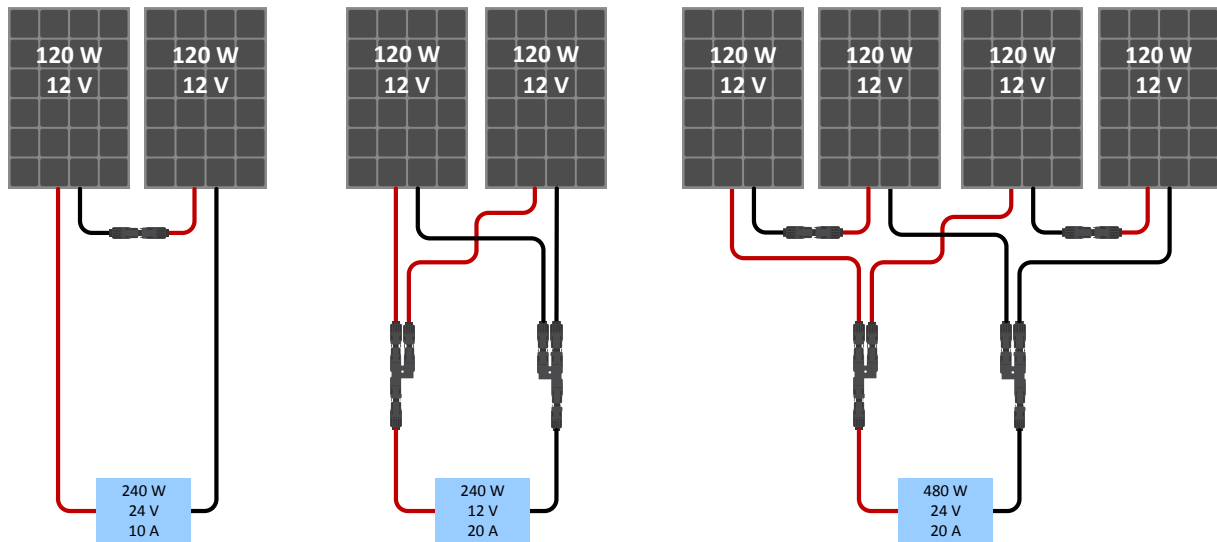

Examples of series, parallel and series/parallel solar arrays.

To help calculate the size of the PV array configuration use the [MPPT sizing calculator](#). Alternatively, use one of these PV array configurations:

PV array example 24V battery with 150V solar charger:

- Minimum number of cells in series: 72 (2x 12V panel in series or 1x 24V panel).
- Recommended number of cells for highest controller efficiency: 144 cells (4x 12V panel or 2x 24V panel in series).
- Maximum: 216 cells (6x 12V or 3x 24V panel in series)

PV array example 48V battery with 150V solar charger:

- Minimum number of cells in series: 144 (4x 12V panel or 2x 24V panel in series).
- Maximum: 216 cells (6x 12V or 3x 24V panel in series).



- Provide a means to disconnect all current-carrying conductors of a photo-voltaic power source from all other conductors in a building or other structure.
- Be aware that at low temperatures and depending on local conditions and cell specifications the open circuit voltage of a solar array may exceed the array's rated maximum open circuit voltage. In that case the number of cells in series must be reduced.
- A switch, circuit breaker, or other device, either AC or DC, shall not be installed in a grounded conductor if operation of that switch, circuit breaker, or other device leaves the grounded conductor in an un-grounded state while the system remains energized.
- Do not use solar panels with optimizers. In worst case, the use of optimizers will cause irreparable damage to the solar charger.
- Use flexible multi stranded copper cable for the screw connections . See chapter [Wiring safety precautions](#) [1].
- For MC4 models: several of the solar charger's MC4 pairs may be needed to parallel solar panel strings. Be aware that the maximum current through a MC4 connection cannot exceed 30A.

4.4. Grounding

Battery grounding

The solar charger can be installed in a positive or in a negative grounded system.

Apply a single ground connection, preferably close to the battery, to prevent system issues or ground loops.

Chassis grounding

A separate ground path for the chassis ground is permitted because the chassis is isolated from the positive and the negative terminals.

PV array grounding

The positive and negative of the PV array should not be grounded.

Ground the frame of the PV panels to reduce the impact of lightning.

Do not connect the solar charger to a grounded PV array. Only one ground connection is allowed, and this should be near the battery.

Ground fault detection

The solar charger does not have internal ground fault protection.

The USA National Electrical Code (NEC) requires the use of an external ground fault protection device (GFPD).

The system electrical negative should be bonded through a GFPD to earth ground at one (and only one) location.



When a ground fault is indicated, battery terminals and connected circuits may be un-grounded and hazardous.

4.5. Electrical connections

Make all electrical connections in the following order:

- Confirm correct battery polarity, then connect the battery (this will allow the solar charger to recognize the system voltage).
Torque moment 1.6Nm.
- Connect the VE.Direct communication cable (if applicable).
- Confirm correct PV polarity, then connect the solar array.
Torque moment TR model 1.6Nm
If accidentally connected in reverse polarity, the PV voltage will drop and the controller will heat up but will not charge the battery.
- In case a MPPT WireBox is used:
First: Secure all electrical cables as indicated in the WireBox installation instructions
Then: Place the WireBox plastic cover over the solar charger connection area and secure it.

See below figure for an example of the solar charger connections:

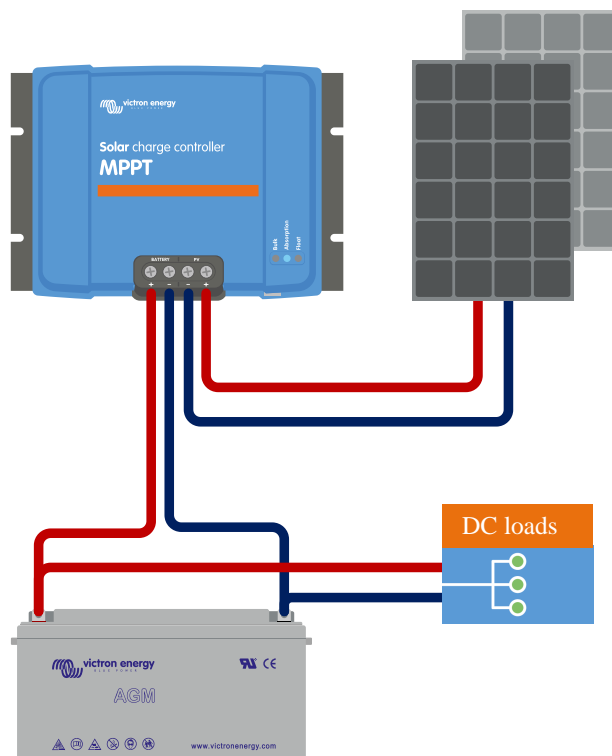

4.6. Connect the MPPT Control display

Connect the (optional) MPPT Control display to the VE.Direct port of the solar charger using a VE.Direct cable.

Note that it is not possible to extend the VE.Direct cable, the maximum length can not exceed 10 meter.

For more information, see the [MPPT Control display manual](#)

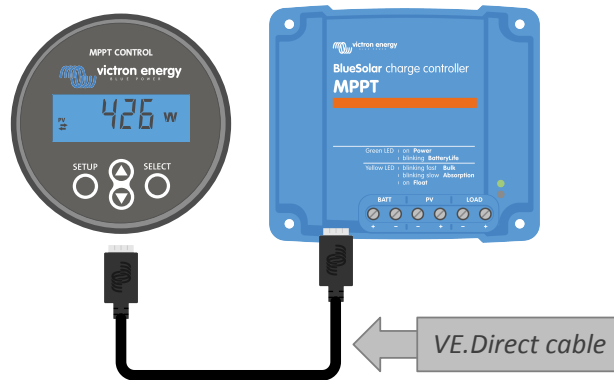

Connect the display to the solar charger via a VE.Direct cable

5. Configuration and settings

The solar charger settings can be configured so it can be tailored specifically for the system it is used in.



Do not change solar charger settings unless you know what they are and what the effect of changing these settings is going to be.

Incorrect settings may cause system problems including damage to batteries. When in doubt, seek advice from an experienced Victron Energy installer, dealer or distributor.

5.1. How to change settings

There are several methods that can be used to change these settings. Some of these allow all settings to be configured, but others might have limitations:

- The VictronConnect App - All settings can be changed and the firmware can be updated.
- The rotary switch - The charge algorithm for a number of pre-set battery types can be selected.
- The MPPT Control display (optional) - Most settings can be changed.





Do not change solar charger settings unless you know what they are and what the effect of changing these settings can be. Incorrect settings may cause system problems including damage to batteries. When in doubt, seek advice from an experienced Victron Energy installer, dealer or distributor.

5.1.1. Settings via the VictronConnect App

The VictronConnect App can be used to change all solar charger settings and can be used to update the firmware.

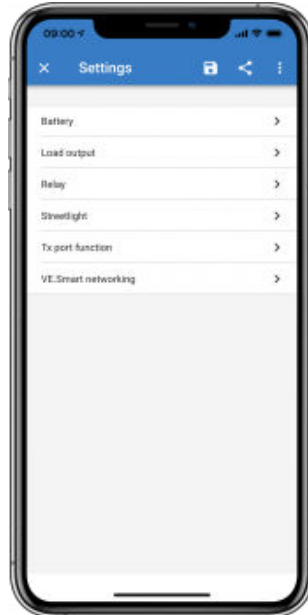
This manual only covers the VictronConnect solar charger specific items. For more general information on the VictronConnect App, like how use it or how to connect see the [VictronConnect manual](#).



To access the solar charger settings, navigate to the settings page. Do this by clicking on the cog icon  at the top right of the home screen.

The settings page provides access to view and/or to change the solar charger settings.

For information about each setting and how to update firmware see the [All settings explained \[15\]](#) chapter.

5.1.2. Settings via the rotary switch

The rotary switch can be used to select eight pre-programmed battery charge algorithms.

Use a small flathead screwdriver to turn the rotary switch. The arrow indicates which setting number has been selected.

The table below indicates the charge algorithm and charge settings for each rotary switch position.



Rotary switch set to position 2

i Turning the rotary switch will override the charge settings including settings that were made with the VictronConnect App or with the display. Likewise, if charge settings are changed with the VictronConnect App or the display, this will override the rotary switch setting.

Switch position	Suggested battery type	Absorption voltage* (V)	Float voltage* (V)	Equalize** voltage* (V)	Equalize** nominal current percentage	Temperature compensation factor* (mV/°C)
0	Gel long life (OPzV)	14.1	13.8	15.9	8%	-16
	Gel Exide A600 (OPzV)	28.2	27.6	31.8		-32
	Gel MK	56.4	55.2	63.6		-64
1	Gel Victron deep discharge	14.3	13.8	16.1	8%	-16
	Gel Exide A200					
	AGM Victron deep discharge					
	Stationary tubular plate (OPzS)					
2	Default setting	14.4	13.8	16.2	8%	-16
	Gel Victron deep discharge					
	Gel Exide A200					
	AGM Victron deep discharge					
Stationary tubular plate (OPzS)	57.6	55.2	64.8	-64		
3	AGM spiral cell	14.7	13.8	16.5	8%	-16
	Stationary tubular plate (OPzS)					
	Rolls AGM					
4	PzS tubular plate traction batteries or OPzS batteries	29.4	27.6	33.0	25%	-32
		58.8	55.2	66.0		-64
5	PzS tubular plate traction batteries or OPzS batteries	14.9	13.8	16.7	25%	-16
		29.8	27.6	33.4		-32
		59.6	55.2	66.8		-64
6	PzS tubular plate traction batteries or OPzS batteries	15.1	13.8	16.9	25%	-16
		30.2	27.6	33.8		-32
		60.4	55.2	67.6		-64
6	PzS tubular plate traction batteries or OPzS batteries	15.3	13.8	17.1	25%	-16
		30.6	27.6	34.2		-32
		61.2	55.2	68.4		-64

* The top value is for 12V systems, the middle for 24V systems and the bottom for 48V systems.

** Equalize is by default disabled. To enable see chapter [Battery settings \[16\]](#)

Switch position	Suggested battery type	Absorption voltage* (V)	Float voltage* (V)	Equalize** voltage* (V)	Equalize** nominal current percentage	Temperature compensation factor* (mV/°C)
7	Lithium Iron Phosphate (LiFePo4) batteries	14.2	13.5	n/a	n/a	0
		28.4	27.0			0
		56.8	54			0

* The top value is for 12V systems, the middle for 24V systems and the bottom for 48V systems.

** Equalize is by default disabled. To enable see chapter [Battery settings \[16\]](#)

A binary LED code helps determining the position of the rotary switch. After changing the position of the rotary switch, the LEDs will blink during 4 seconds as indicated in below table. Thereafter, normal indication resumes, as described in the LEDs section.

Switch position	Bulk LED	Absorption LED	Float LED	Blinking frequency
0	1	1	1	Fast
1	0	0	1	Slow
2	0	1	0	Slow
3	0	1	1	Slow
4	1	0	0	Slow
5	1	0	1	Slow
6	1	1	0	Slow
7	1	1	1	Slow

5.1.3. Settings via MPPT Control display

The MPPT Control display can be used to configure solar charger settings, with the exception of advanced settings such as RX and TX port settings. For information how to do this see the [MPPT Control display manual](#).

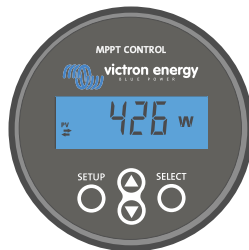

The MPPT Control display

5.2. All settings explained

This chapter lists all solar charger settings that are user-configurable and also explains how to update firmware of the solar charger.



Do not change settings unless you know what they are and what the effect of changing these settings will be. Incorrect settings may cause system problems including damage to batteries. When in doubt, seek advice from an experienced Victron Energy installer, dealer or distributor.

5.2.1. Battery settings

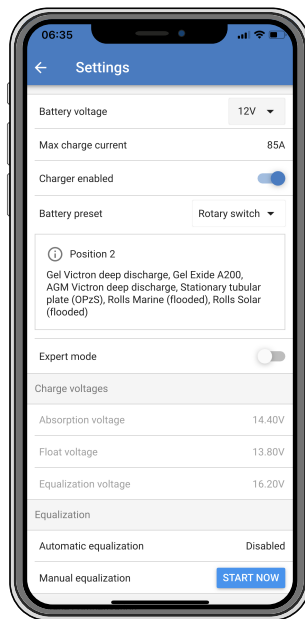

Battery voltage

The battery voltage is automatically detected at the very first power-up of the solar charger and the battery voltage is set accordingly. Further automatic detection is disabled. If the battery voltage is less than 7V during automatic detection, the battery voltage will be temporarily set at 12V and the automatic detection is rescheduled for the next power-up.



The solar charger will not automatically detect a 36V battery. This will need to be set manually.

After automatic detection has taken place, the battery voltage can be changed and set to 12, 24, 36 or 48V, if so required .



If the firmware of the solar charger needs to be updated, while keeping the automatic voltage detection active, for example before shipping the unit to an end-user, do the following:

- Update the firmware.
- Once the firmware update is complete, go to the settings page on VictronConnect.
- On the settings page click on the three vertical dots in the upper right corner and select "Reset to defaults" from the drop-down menu.
- Un-power the solar charger.

When the unit is powered up the next time it will again perform the initial automatic voltage detection.

Max charge current

This setting sets the maximum battery charge current. It is by default set to the maximum solar charge current.

Use this setting to reduce the charge current, for example, when a smaller battery bank is used that requires a lower charge current.

Charger enabled

This setting enables or disables the battery charger. It is by default set to "enabled".

This setting can be used when work needs to be carried out on the installation. When this setting is disabled, the batteries will not be charged.

Battery preset

This setting sets the battery charge algorithm. It is by default set to "rotary switch".

A selection can be made between:

- The rotary switch position
- Pre-defined factory battery presets

- User defined battery presets
- Create, modify or delete a user defined preset.

This setting uses factory pre-defined presets for a large variety of battery types. These pre-defined charge algorithms are suitable for almost all installations.

It is possible to also create user-defined battery presets. The chapter [Customize battery charge algorithm \[17\]](#) explains how to do this. These user defined presets are stored in the VictronConnect app library. This is helpful in case multiple solar chargers need to be configured, eliminating the need to define the entire charge algorithm each time a new solar charger is configured.

Expert mode

This setting enables or disables expert mode. It is by default set to "disabled".



The default charge algorithms work well for almost all installations. Only enable expert settings if your equipment has special requirements.

When this setting is enabled the following parameters can be configured:

- Charger voltages: bulk, absorption and float
- Bulk: re-bulk voltage offset
- Absorption: duration, time and tail current
- Equalization: current, interval, stop mode and duration
- Temperature voltage compensation
- Low temperature cut off

For the meaning of these parameters see chapter [Battery charge algorithm settings \[18\]](#)

Equalization



Equalization can cause damage to the battery if the battery is not suitable for an equalization charge. Always check with the battery manufacturer prior to enabling equalization.

This setting can be used to disable or enable automatic equalization. When enabled, the amount of days can be selected when equalization should repeat.

A manual equalization can be initiated by pressing the "START NOW" button. Use the manual equalize option only during absorption and float charge stages, and when there is sufficient sunlight. The current and voltage limits are identical to the automatic equalize function. The manual equalization stage lasts 1 hour, and can be stopped at any time by the Stop Equalize.



The equalization setting might not be active, this can be the case if the battery preset does not support an equalization charge, like is the case with lithium batteries.

Customize battery charge algorithm

This chapter explains how to modify a battery charge algorithm or to create, modify and delete user defined battery presets. See the [Battery charge algorithm settings \[18\]](#) chapter for the meaning of all charge algorithm parameters.

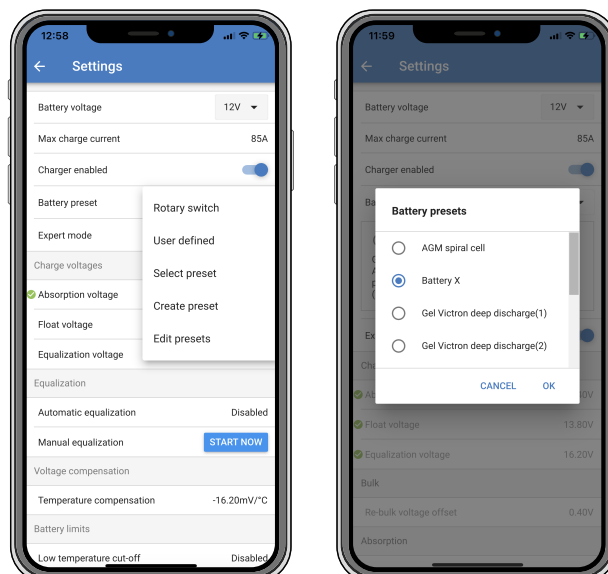



Only experienced users should configure or edit user defined battery charge algorithms. A wrongly defined battery charge algorithm can lead to battery damage or create unsafe situations.

To Modify a basic battery charge algorithm:

- Select a preset battery type that is the best match to your battery type.
- Change one of the basic charge parameters that are listed on the settings screen.
- Configure the required parameters.
- The battery preset is now set to "user defined".

To Modify an expert battery charge algorithm

- Enable "Expert" mode.
- The basic and additional charge parameters are now listed on the screen.
- Configure the required parameters.
- The battery preset is now set to "user defined".

To create and save a custom battery type:

- Select a preset battery type that is the best match to your battery type.
- Change the charge parameters so they match your battery. This can be done either in normal mode or in expert mode.
- The battery preset is now set to "user defined".
- Select in the "Battery preset" menu "Create preset".
- Give the preset battery a name.

To load a custom battery type:

- Select in the "Battery preset" menu "Select preset".
- The menu lists all factory preset and custom battery types that were previously added (if any).
- Select the battery type of your choice.

To modify (or delete) a custom battery type:

- Select in the "Battery preset" menu "Edit presets"
- Navigate to the battery you want to modify. It is not possible to modify a factory preset, only custom types can be modified (or deleted).
- Modify the charge parameters.
- To save the settings press the "SAVE CHANGES" button at the bottom of the page.
- To delete the battery, press the "REMOVE PRESET" button.

Battery charge algorithm settings

This chapter explains all parameters that are used in "Expert" mode and the settings that are used when programming a custom battery type via the battery preset menu.

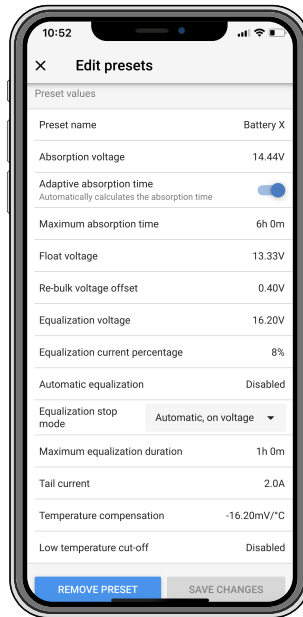

Absorption voltage

This setting sets the absorption voltage.

Adaptive absorption time

This setting enables or disables the adaptive absorption time.

- **When disabled:** The length of the absorption stage is the same each day, the length is determined by the "Maximum absorption time" setting, provided there is enough solar power.

Be aware that this option can potentially result in overcharging your batteries, especially for lead batteries and if only shallow daily discharges take place. Check with the battery manufacturer for the recommended maximum absorption time.

The only condition that can end the absorption time before the maximum time has been reached, is the "tail current" setting. If the absorption time always needs to be the same length, then disable the "Tail current" setting. See more information on the tail current setting further down in this chapter.

- **When enabled:** The length of the absorption stage is different each day, it adapts itself to the state of charge of the battery in the morning at the beginning of the charge cycle.

The maximum "adaptive" absorption time for the day is determined by the battery voltage as measured just before the solar charger begins operation each morning.

Multiplier	x 1	x 2/3	x 1/3	x 1/6
Adaptive absorption time *	6:00 hours	4:00 hours	2:00 hours	1:00 hour
12V system	$V_{batt} < 11.9V$	$11.9V < V_{batt} < 12.2V$	$12.2V < V_{batt} < 12.6V$	$V_{batt} > 12.6V$
24V system	$V_{batt} < 23.8$	$23.8 < V_{batt} < 24.2V$	$24.2V < V_{batt} < 25.2V$	$V_{batt} > 25.2V$
48V system	$V_{batt} < 47.6$	$47.6 < V_{batt} < 48.8V$	$48.8V < V_{batt} < 50.4V$	$V_{batt} > 50.4V$

*) The adaptive absorption time is calculated by the multiplier times the "Maximum absorption time" setting. The adaptive absorption times in this table are based on the 6 hour default "Maximum absorption time" setting.

Maximum absorption time

This setting sets the absorption time limit. This setting is only available when programming a custom charge profile.

Enter the maximum time in hours and minutes (hh:mm) the solar charger is allowed to spend in the absorption stage. The maximum time that can be set is 12 hours and 59 minutes.

Float voltage

This setting sets the float voltage.

Re-bulk voltage offset

Sets the re-bulk voltage offset. This offset voltage is used to determine when the float stage stops and the bulk stage starts again, i.e. the charge cycle resets and starts at first charge stage again.

An example: If the re-bulk offset is set at 0.1V and the float voltage at 13.8V, the charge cycle will restart once the battery voltage drops below 13.7V (13.8 minus 0.1) for one minute.

Equalization voltage

This setting sets the equalization voltage.

Equalization current percentage

This setting sets the percentage of the "maximum charge current" setting that will be used to calculate the equalization charge current.

For example: If the "maximum charge current" setting is set at 50A and the "Equalization current percentage" setting is set to 10%, the Equalization current will be 5A (10% of 50).

Automatic equalization

This setting sets the repeat interval when the equalization stage should take place. This can be set between 1 and 250 days. Setting to 1 means a daily equalization, 2 means every other day and so on.

An equalization stage is typically used to balance the cells and also to prevent stratification of the electrolyte in flooded lead-acid batteries. If equalization is needed or not depends on the type of battery if (automatic) equalization is needed and under what conditions. Check with the battery supplier to find out if equalization is needed for the battery.

During the equalization stage, the charge voltage increases up to the set "Equalization voltage". This is maintained as long as the charge current stays below the "equalization current percentage" setting of the "Maximum current" setting.

Duration of the Automatic equalization cycle:

- For all VRLA battery presets and for some flooded batteries presets, the automatic equalization stage ends when the voltage limit (maxV) has been reached, or after a period equal to absorption time/8, whichever comes first.
- For all tubular plate battery presets and for user-defined battery types, the automatic equalization stage ends when the time has reached absorption time/2.
- For the lithium battery preset, equalization is not available.
- When an automatic equalization stage has not been completed within one day, it will not resume the next day. The next equalization surge will take place according to the interval as set in the "Auto Equalization" setting.

Equalisation stop mode

This setting determines when the equalisation stage should end:

- **Automatic:** Equalization stops if the battery voltage has reached the equalisation voltage
- **Fixed time:** Equalization stops when the time has reached the time as set in the "Maximum equalization duration" setting.

Maximum equalization duration

This setting sets the maximum time that the equalization stage will last.

Tail current

This setting sets the current threshold to end the absorption stage before the maximum absorption time has been reached. If the charge current drops below the set tail current, for one minute, the absorption stage will end and the float stage will start. This setting can be disabled by setting it to zero.

Temperature compensation

This setting sets the temperature compensation coefficient that is needed for temperature compensated charging.

Many battery types require a lower charge voltage in warm operating conditions and a higher charge voltage in cold operating conditions. The configured coefficient is in mV per degree Celsius for the whole battery bank, not per cell. The base temperature for the compensation is 25°C (77°F).

The chart below indicates the absorption and float charge voltage behaviour at different temperatures. The graph displays the temperature compensation for a 12V system and uses a -16mV/°C temperature compensation coefficient. For a 24V system multiply the voltages by 2 and for a 48V system multiply by 4.

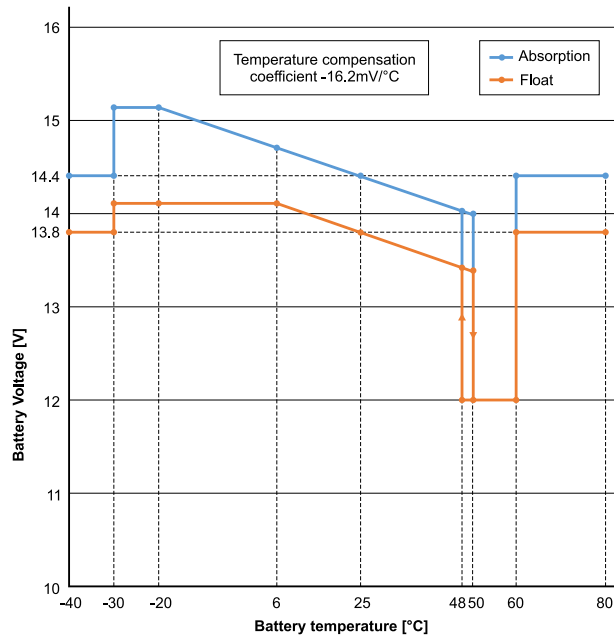

Temperature compensated charge graph

By default, the solar charger uses its internal temperature for battery temperature compensated charging. An internal temperature reading is taken in the morning and then again when the solar charger has been idle for at least one hour, for example when the charger is not actively charging a battery or supplying a load.

When the solar charger is part of a VE.Smart network and receives a battery temperature reading from a Battery Sense or a battery monitor with temperature sensor, the actual battery temperature will be used for temperature compensated charging throughout the day.

Low temperature cut-off

This setting is used to prevent damage to a lithium battery by disabling charging at low temperatures.



The "Low temperature cut-off" feature is only active when the solar charger is part of a VE.Smart network and is receiving a battery temperature reading from a Battery Sense or a battery monitor with temperature sensor.

The "low temperature cut-off" setting is by default disabled. When enabled, a low cut off temperature can be set. The default temperature is 5°C, this is a suitable temperature setting for lithium iron phosphate (LFP) batteries. However, always check with the lithium battery supplier to find out what this temperature should be set at.

The "low temperature cut-off" mechanism will stop battery charging when the battery temperature has dropped below the low temperature cut-off setting. Battery charging will resume once the battery temperature has risen 0.5°C above the low temperature cut-off setting.

Note that setting "low temperature cut-off" is not needed for Victron Lithium Smart batteries or for Victron Super Pack batteries with serial number HQ2040 and above. This setting is only needed for lithium batteries that are unable to block charging when the temperature drops too low.

5.2.2. Load output settings

The load output settings be used to drive the TX pin in the VE.Direct port, which can then be used to drive a BatteryProtect, a relay or an other load-shedding device. For more information see chapter [TX port settings \[25\]](#).

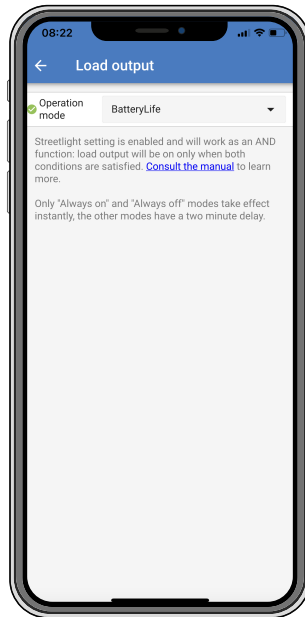

The available operation modes are:

- **Always off**
The load output is always OFF
- **BatteryLife algorithm:**
This is a self adapting algorithm to maximize life of the battery. For more information see chapter ???.
- **Conventional algorithm 1:**
12V system: OFF when $V_{batt} < 11.1V$, ON when $V_{batt} > 13.1V$
24V system: OFF when $V_{batt} < 22.2V$, ON when $V_{batt} > 26.2V$
48V system: OFF when $V_{batt} < 44.4V$, ON when $V_{batt} > 52.4V$
- **Conventional algorithm 2:**
12V system: OFF when $V_{batt} < 11.8V$, ON when $V_{batt} > 14.0V$
24V system: OFF when $V_{batt} < 23.6V$, ON when $V_{batt} > 28.0V$
48V system: OFF when $V_{batt} < 47.4V$, ON when $V_{batt} > 56.0V$
- **Always on:**
The load output is always ON
- **User defined algorithm 1:**
OFF when $V_{batt} < V_{low}$, ON when $V_{batt} > V_{high}$.
- **User defined algorithm 2:**
OFF when $V_{batt} < V_{low}$ or $V_{batt} > V_{high}$ and ON when V_{batt} is between V_{low} and V_{high} .

The "always off" and the "always on" modes will respond immediately. The other modes have a 2 minute delay before the load output changes. This is so that the solar charger does not respond too quickly when, for example, an inrush current briefly lowers the battery voltage below the threshold.

The load output settings also controls the streetlight algorithm. Both work together to protect the battery from being too deeply drained. The streetlight settings are overridden should the battery voltage falls below the load disconnect voltage. When the battery voltage increases to the load reconnect voltage, the streetlight function will resume.

5.2.3. Streetlight settings

The streetlight function enables the solar charger to automatically control night lighting. It will automatically determine when the light should be on or off and can control the light intensity.

When the streetlight function is enabled a timer program can be created whereby Sunset, Sunrise as well as Midnight can be used as anchor points for the timer program. These anchor points will automatically adjust depending on length of the night as this changes with the seasons.

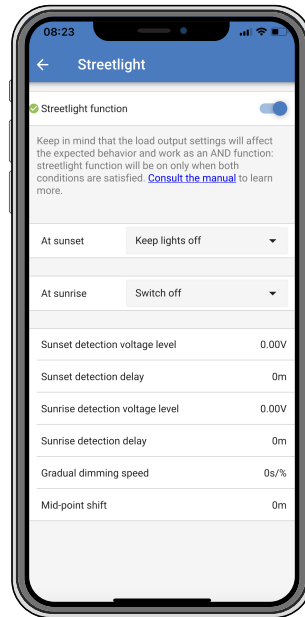

Streetlight control

The solar charger controls the streetlight:

- Via the TX port together with a [VE.Direct TX digital output cable](#). Also see the [TX port settings \[25\]](#) chapter for more details.



The streetlight algorithm is always applied in conjunction with the settings as configured in the Load output menu:

- If the streetlight is disabled, then the (virtual) load output is controlled only by the configuration as made in the load output menu.
- If streetlight is enabled, then it's an AND function: the load output will be on when both the conditions made in the Load output menu are satisfied as well as the streetlight settings. Otherwise, it's off.

Make sure that load output setting is set to "Always on" or to "BatteryLife". Do not set it to "Always off" as this will result in the light being always off.

For more configurable voltage levels to force the light off, the other load output options can also be used.

Setting the Sunset action

At sunset you can choose any of the following actions:

- **Keep the lights off**

- **Switch on for a fixed time:**

This option will turn the light on at sunset, and then off again after a configurable interval. When the dimming feature is enabled¹ (1), two dim-levels can be entered: one for the "on" period; and a second for the "off" period. A typical use case for these options is to get a strong light during high traffic hours (right after sunset), and lower intensity during the low hours, to save the battery. Set the second dim level to 0% to switch the light completely off during that second section.

- **Switch on till midnight:**

This option turns the light on at sunset, and then off again at midnight. When the dimming feature is enabled¹, two dim-levels can be entered: one for the "on" period (up to midnight) and a second dim-level for the "off" period after midnight. Set the second dim level to 0% to switch the light completely off during that second section.

- **Switch on till sunrise:**

This options turns the light on at sunset, and then off again at sunrise. When this option is selected; there is no need to also select an action at sunrise, so the sunrise control option is not needed. When the dimming feature is enabled¹, only one dim level can be configured, the dim level at sunset.

¹) The dimming feature requires the TX Port function to be configured to one of the "Light dimming" settings. This so the TX port outputs a PWM signal that can be used to dim the light. If the TX port function has not been set to one of the "Light dimming" settings, the dimming options will not appear in the sunset settings menu. Also see the [TX port settings \[25\]](#) chapter.

Setting the Sunrise action

At sunrise you can choose to:

- **Switch off:**

Turns the light off at sunrise

- **Switch on before sunrise:**

This option switches the light on at a configurable time interval before sunrise, and then switches the light off at sunrise.

In case the dimming feature is enabled¹ an interval of more intense light can be configured during early morning rush hour. Together with the Sunset action, you can now configure three dim levels: one for the sunset rush hours, one during the low traffic hours, and the third for the early morning rush hours.

Midnight

The charger has no real time clock, and therefore does not know when it is 12 o'clock at night. All references to midnight refer to what we call solar midnight, this is the mid-point between sunset and sunrise.

Midnight and Sunrise synchronisation

The solar charger needs to have its internal clock synchronised with the solar cycle so it can set the solar midnight and sunrise anchor points in the timer program.

After the streetlight settings have been programmed and the solar charger is powered up, the solar charger will start unsynchronised. It will first assume that midnight is 6 hours after sunset, and that the full night last for 12 hours.

Once in operation, the solar charger will check the time between each detected sunrise. After three full day/night cycles, where the detected time is approximately 24 hours (one hour of deviation is allowed), it will start using its internal clock, instead of the fixed 6 and 12 hour timing.



A loss of power (no battery power together with no PV power) will cause the solar charger to lose its synchronisation. It will take 5 days before it is re-synchronised. Note that the streetlight configuration settings and all other settings will never be lost, they are stored in a non-volatile memory.

Sunset and sunrise detection

The sunset and sunrise detection voltage settings can be used to adjust the detection to match the panel configuration. The sunrise detection voltage must be 0.5V higher than the sunset detection level. The lowest detectable voltage is 11.4V. Set this option to 0 to use the built-in defaults, which are:

- Sunset = $V_{\text{panel}} < 11.4\text{V}$
- Sunrise = $V_{\text{panel}} > 11.9\text{V}$

The default setting is 0, which uses built-in default voltages.

Use the "Delay" periods to avoid the system making an accidental switch when clouds pass over the panels. The valid range is between 0 and 60 minutes. The "Delays" are disabled by default (0).

Gradual dimming speed

The gradual dimming option can be used to slow down the response of the timer program. This is useful when multiple streetlights are used in a row. This helps to mask the fact that each timer uses its own detection and will have a transition moment which will vary from unit to unit.

The dimming settings can be adjusted. You can input the number of seconds required to achieve each percentage-point of change (x seconds/per 1% of dimming). A number from 0 to 100 can be entered. Two examples:

- 0 = immediate response (gradual dimming disabled):
A setting of 0 will achieve an immediate response, this effectively means that the gradual dimming option is disabled.
- 9 = dim from 0 to 100% in 15 minutes:
Setting the dimming speed to 9, for example, slows down the dimming speed to 15 minutes (9 seconds for each percentage point of dimming x 100 percentage points = 900 seconds = 15 minutes).



Make sure that the TX port function is set to "Light dimming" mode (as described in point ¹ at the beginning of this chapter) and connect a VE.Direct TX digital output cable to the PWM dim input of your LED driver.

Mid-point shift

The time of midnight is estimated based on solar activity, and depends on your geographical location. Daylight saving times can cause a further deviation between the "solar" and the "clock" midnight. The Mid-point shift function will compensate for these differences. Use 0 to disable the shift (default).



The Mid-point shift setting is only relevant when your streetlight setting program uses "Midnight" as a switching moment.

Calculation Example:

For calculation we use a day of 1440 minutes, where Sunset is at 19:00 (1140 minutes) and Sunrise is at 6:25 (385 minutes):

- The night duration in minutes is: $1440m^{(\text{min/day})} - 1140m^{(\text{time to sunset})} + 385m^{(\text{time to sunrise})} = 685m$
- The degree of shift = $\text{time of sunset}^{(\text{minutes})} + \text{half the duration of night}^{(\text{minutes})} - \text{length of day}^{(\text{minutes})} = 1140m + 342m - 1440m = 42 \text{ minutes.}$

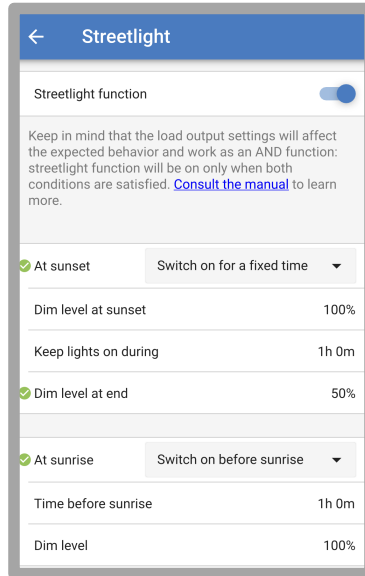
Example configuration

The selections which have been made on above screen image results in this program:

- At sunset - the light will be switched on for a fixed time
- Dim level at sunset - at Full brightness (100%)
- Keep lights on during - the duration has been set to 1h 0m
- Dim level at end - at the end of one hour the brilliance will be reduced to half (50%)

Also:

- At sunrise - the lighting will be adjusted before sunrise
- Time before sunrise - at 1h 0m before sunrise, the following adjustment will be made:
- Dim level - full brilliance will be restored (100%)

5.2.4. TX port settings

The VE.Direct-TX port can be used to send a signal to an external device. For example to send a PWM signal to dim a streetlight.

To use the TX port, a [VE.Direct TX digital output cable](#) is needed.

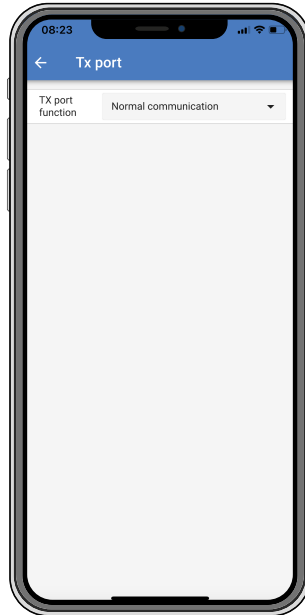

The functionality of the TX port can be set at:

- **Normal communication:**

This is the default setting. Use this function when connecting to a GX device, a VE.Direct Bluetooth Smart dongle, or any other device that needs to communicate with the solar charger via the VE.Direct port.

- **Pulse every 0.01 kWh:**

Use this function in combination with an energy meter.

The TX port will emit a pulse each time an additional 0.01kWh of energy has been harvested. The TX port is normally high and will be driven low for approximately 250ms for every 0.01kWh harvested.

- **Light dimming (PWM normal):**

Use this function in combination with the "Streetlight" setting.

The TX port PWM* signal will be at 100% duty cycle when full light intensity is required.

- **Light dimming (PWM inverted):**

Use this function in combination with the "Streetlight" setting.

The TX port PWM* signal will be at 0% duty cycle when full light intensity is required.

- **Virtual load output:**

Use this function to create a virtual load output if the solar charger does not have a physical load output.

The TX port will switch using the same conditions as set in the load output settings.

Connect the VE.Direct TX digital output cable to a BatteryProtect module, a relay or directly to the remote on/off connector of the load.

*) The PWM signal is 5V, 160Hz.

Note that these functionalities (other than the first functionality) does not disable the ability of the unit to communicate. What happens is that the unit will automatically detect incoming data, and while data is being received it will resume normal communication. Once the data-reception has been completed it will automatically return to its configured TX function.

For more in depth "developer style" information on the VE.Direct port see Technical Information: [Data communication with Victron Energy products](#) .

5.2.5. RX port settings

The VE.Direct-RX port can be used to receive a signal from an external device. For example to switch the solar charger on (or off) from a signal sent by a battery management system (BMS).

To use the RX port for remote on/off control a [VE.Direct non inverting remote on/off cable](#) is needed.

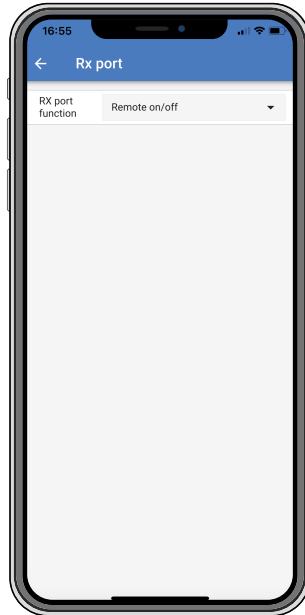

The functionality of the RX port can be set at:

- **Remote on/off:**

This is the default setting. This functionality will switch the solar charger on or off via the RX pin.

- RX pin to GND will switch the solar charger off.
- RX pin floating or to battery positive will switch the solar charger on.

- **Load output on/off inverted:**

This setting reverses the load output on/off control:

- RX pin 0V will switch load output on
- RX pin +5V will switch load output off

- **Load output on/off normal:**

This setting allows load output on/off control:

- RX pin 0V will switch the load output off
- RX pin +5V will switch load output on



For more in depth "developer style" information on the VE.Direct port see the [Data communication with Victron Energy products Whitepaper](#).

5.3. Updating firmware

The firmware can be checked and updated with VictronConnect.

VictronConnect might ask on first connection to update firmware. If this is the case, let it perform a firmware update.

If it did not automatically update, check if the firmware is already up to date using the following procedure:

- Connect to the solar charger
- Click on the settings symbol 
- Click the option symbol 
- Go to product info
- Check if you are running the latest firmware and look for the text: "This is the latest version"
- If the solar charger does not have the most up to date firmware, perform a firmware update

5.4. VE.Smart network

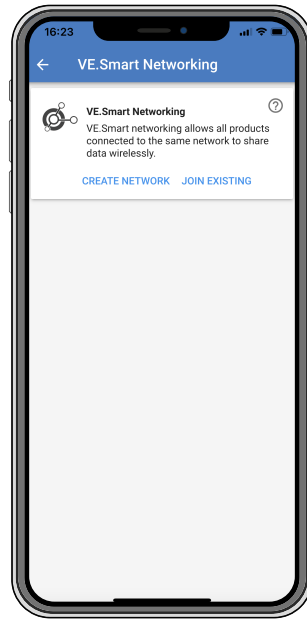

The VE.Smart network allows a variety of products connected to the same network to share data via Bluetooth. The VE.Smart network is especially designed for smaller systems that do not have a GX device installed.

When this product is part of a VE.Smart network it can receive data or communicate with the following devices:

- All SmartSolar solar chargers
- All BlueSolar solar chargers that are connected to a [VE.Direct Bluetooth Smart dongle](#).
- The [Smart Battery Sense](#)
- A [BMV](#) or [SmartShunt battery monitor](#) equipped with Bluetooth (or [VE.Direct Bluetooth Smart dongle](#)) and a optional [BMV temperature sensor](#).
- Certain AC chargers
- SUN inverter

For the product compatibility list see the VE.Smart manual located on the [VictronConnect app product page](#).

The VE.Smart network can be used for:

- Temperature sensing - the measured battery temperature is used by the chargers in the network for temperature compensated charging and in case of lithium battery for the low temperature cut off.
- Battery voltage sensing - the measured battery voltage is used by the chargers in the network to to compensate the charge voltage should there be a voltage drop over the battery cables.
- Current sensing - The measured battery current is used by the charger so it knows the exact tail current at which the absorption stage should end and the float (or equalisation) stage should start. To measure the charge current all charge currents from all chargers are combined, or if a battery monitor is part of the network the actual battery current will be used.
- Synchronised charging - All chargers in the network will act as they were one large charger. One of the chargers in the network will assume a master role and the master will dictate the charge algorithm the other chargers will be using. All chargers will follow the same charge algorithm and charge stages. The master is selected randomly (not user settable) so it is important that all chargers use the same charge settings. During synchronised charging each charger will charge up to its own maximum charge current setting (it is not possible to set a maximum current for the whole network). For more information see the VE.Smart manual located on the [VictronConnect app product page](#).

This video introduces the Smart Battery Sense and some features of the VE.Smart network:

<https://www.youtube.com/embed/v62wCfXaWXY>

5.4.1. VE.Smart network setup

VE.Smart network design notes:

There can only be one product in the network that transmits battery voltage and/or battery temperature. It is not possible to use a battery monitor together with a Smart Battery Sense, or multiples of these devices.

For the network to be operational all networked devices must be within Bluetooth transmission distance of each other.

A maximum of 10 devices can be joined into a VE.Smart network.

Some older devices might not support VE.Smart networking. for more information see the Limitations chapter in the VE.Smart Networking manual.

Setting up the network

When setting up the network, first set up the Smart Battery Sense or battery monitor, and then add one or more solar chargers or AC chargers to the network.

All solar chargers and AC chargers need to have the same charge settings. The easiest way to do this is to use a preset battery type or a saved used defined battery type. A warning #66 message will be shown if there is a difference between the devices charge settings.

To set up a new network:

- Open the VictronConnect app.
- Select one of the devices that needs to become part of the new VE.Direct network.
- Navigate to the settings page by clicking the gear  symbol.
- click on "VE.Smart networking".
- Click on "create network".
- Enter a name for the new network.
- Click "save".
- Wait for confirmation that the network has been set up and click "OK".
- If more devices need to be added to this network go to next paragraph and join multiple devices to the network.

To join another device to an existing network:

- Open the VictronConnect app. Select a device that needs to become part of a VE.Direct network.
- Navigate to the settings page by clicking the gear  symbol.
- Click on "VE.Smart networking".
- Click on "join existing".
- Select the network the device needs to be joined to.
- Wait for confirmation that the network has been set up and click "OK".
- Repeat above steps if more devices need to be added to the network.

To leave a network:

- Open the VictronConnect app.
- Select a device that needs to be removed from the VE.Direct network.
- Navigate to the settings page by clicking the gear  symbol.
- Click on "VE.Smart networking".
- Click on "leave network".

Check the network

Once the network has been set up all devices communicate with each other. The active LED on each connected device will now blink every 4 seconds. This is an indication that the device is actively communicating with the network.

To check if an individual device is communicating with the network, click on the VE.Smart symbol  in the main screen next to the solar dial. A pop-up window will open showing the connection status and the shared parameters.

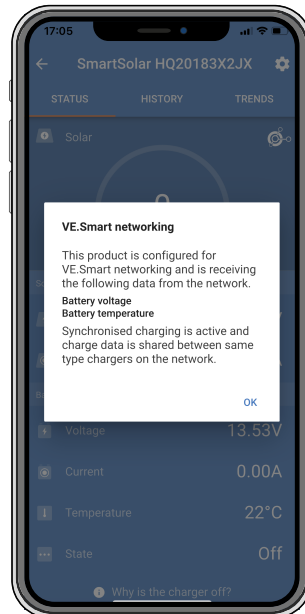

VE.Smart network pop-up

To check if all devices are actively communicating with the same VE.Smart network, navigate to the settings page of one of the networked devices and click on "VE.Smart networking". A screen will be shown containing which device parameters of this device are shared and all the other devices that are connected to the same network are shown.

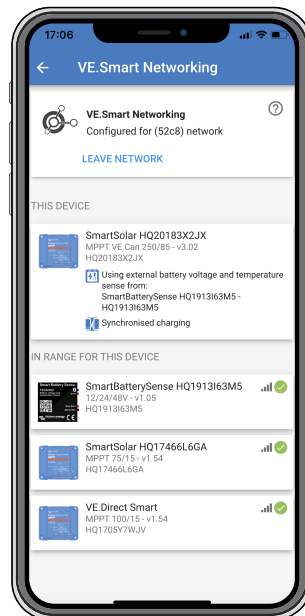

Example of a VE.Smart network

More information

For more information see the [VE.Smart Networking manual](#).

6. Operation

6.1. Start up

The solar charger will power up as soon as it has been connected to a battery and/or to a solar panel. As soon as the solar charger has been powered up, it can communicate via the VE.Direct port. The solar charger's data can be read out and setting configurations can be made using the VictronConnect or the optional display.

The solar charger will commence battery charging as soon as the PV voltage is 5V higher than the battery voltage. For charging to continue, the PV voltage must remain at least 1V higher than the battery voltage.

6.2. Battery charging

The charge controller will start a new charge cycle every morning, when the sun starts shining and when the PV voltage is 5V higher than the battery voltage.

Default method to determine length and end of absorption for Lead-acid batteries

The charging algorithm behaviour of solar chargers differ from AC connected battery chargers. Please read this section of the manual carefully to understand the solar charging behaviour, and always follow the recommendations of your battery manufacturer.



The voltage values mentioned in this chapter are for 12V systems, for 24V systems multiply by 2 and for 48V systems multiply by 4.

By default, the absorption time is determined on idle battery voltage at the start of each day based on the following table:

Battery voltage at start up	Multiplier	Maximum absorption time
< 11.9V	x 1	6h
11.9V - 12.2V	x 0.66	4h
12.2V - 12.6V	x 0.33	2h
> 12.6V	x 0.16	1h

The default absorption voltage is 14.4V and the default float voltage is 13.8V.

The absorption time counter starts once switched from bulk to absorption.

The MPPT solar chargers will also end absorption and switch to float when the battery current drops below a low current threshold limit, the "tail current". The default tail current value is 2A.

The default settings (voltages, absorption time multiplier and tail current) can be modified with the VictronConnect App.

There are two exceptions to normal operation:

- When used in an ESS system; the solar charger algorithm is disabled; and instead it follows the curve as mandated by the inverter/charger.
- For CAN-bus Lithium batteries, like BYD, the battery tells the system, including the solar charger, what charge voltage to use. This Charge Voltage Limit (CVL) is for some batteries even dynamic; changes over time; based on for example maximum cell voltage in the pack and other parameters.

Variations to the expected charging behaviour

Pausing of the absorption time counter:

The absorption time counter starts when the configured absorption voltage is reached and pauses when the output voltage is below the configured absorption voltage. An example of when this voltage drop could occur is when PV power (due to clouds, trees, buildings) is insufficient to charge the battery and to power the loads.

Restarting the charge process:

The charging algorithm will reset if charging has stopped for an hour. This may occur when the PV voltage drops below the battery voltage due to bad weather, shade or similar.

Battery being charged or discharged before solar charging begins:

The automatic absorption time is based on the start-up battery voltage (see table). This absorption time estimation can be incorrect if there is an additional charge source (eg alternator) or load on the batteries. This is an inherent issue in the default algorithm. However, in most cases it is still better than a fixed absorption time regardless of other charge sources or battery state. It is possible to override the default absorption time algorithm by setting a fixed absorption time when programming

the solar charge controller. Be aware this can result in overcharging your batteries. Please see your battery manufacturer for recommended settings.

- Absorption time determined by tail current:

In some applications it may be preferable to terminate absorption time based on tail current only. This can be achieved by increasing the default absorption time multiplier (warning: the tail current of lead-acid batteries does not decrease to zero when the batteries are fully charged, and this “remaining” tail current can increase substantially when the batteries age).

Default settings for LiFePO4 batteries

The default absorption voltage is to 14.2V (28.4V, 56.8V) and the absorption time is fixed and set to 2 hours. The float voltage is set at 13.5V (27V, 54V). Equalization is disabled. The tail current is set to 0A, this so that the full absorption time is available for cell balancing. The temperature compensation is disabled and the low temperature cut off is set to 5. These settings are the recommended settings for LiFePO4 batteries, but they can be adjusted if the battery manufacturer specifications advise otherwise.

Reset of the charge algorithm:

The default setting for restarting the charge cycle is $V_{bat} < (V_{float} - 0.4 V)$ for lead-acid, and $V_{bat} (V_{float} - 0.1 V)$ for LiFePO4 batteries, during 1 minute. These values are for 12 V batteries, multiply by two for 24V and by four for 48V.

6.3. Automatic equalization



Do not equalize charge Gel, AGM, VRLA or lithium batteries.

Equalization can cause damage to the battery if the battery is not suitable for an equalization charge. Always check with the battery manufacturer prior to enabling equalization.

Automatic equalization is by default disabled. When enabled, it can be configured with a number between 1 (every day) and 250 (once every 250 days).

When automatic equalization is active, the absorption charge will be followed by a voltage limited constant current period. The current is by default limited to 8% of the bulk current and can be adjusted between 0% and 100%. The bulk current is set by default to the maximum charge current the solar charger is capable of, unless a lower charge current has been chosen.

The maximum equalization duration is set by default to 1 hour and can be configured between 0 minutes and 24 hours. The automatic equalization will end when the voltage limit has been reached or when the set maximum equalization duration has been reached, whichever comes first.

When automatic equalization has not finished within a day, it will not resume the next day. The next equalization session will take place as determined by the day interval.

6.4. Lithium batteries

Lithium Iron Phosphate (LiFePo4) batteries do not need to be fully charged to prevent premature failure. The default lithium (and recommended) settings are:

Setting	12V system	24V system	48V system
Absorption voltage	14.2V	28.4V	56.8V
Absorption time	2h	2h	2h
Float voltage	13.2V	26.4V	52.8V

These settings are adjustable.

6.5. Shutdown and restart procedure

The solar charger is always active when the PV and/or the battery terminals are powered. The solar charger does not have an on/off switch.

To shut down the solar charger, perform these steps in the prescribed order:

1. Disconnect the PV supply to the solar charger by switching the PV supply off or by removing the fuse(s).
2. Disconnect the battery supply to the solar charger by switching the battery supply off or by removing the fuse(s).

To restart the solar charger after it was shutdown, perform these steps in the prescribed order:

1. Connect the battery supply to the solar charger by switching the battery supply on or by inserting the fuse(s).
2. Reconnect the PV supply to the solar charger by switching the PV supply on or by inserting the fuse(s).

6.6. Maintenance procedure

The solar charger does not need regular maintenance.



7. Monitoring

This chapter describes all various monitoring methods and for each method how to access live data, historic data and errors.



















7.1. LED indications

The solar charger has three LEDs to indicate operational status, a blue, green and a yellow LED. These LEDs respectively indicate the charge stages bulk, absorption and float, but are also used to indicate other charge situations and fault situations.















Errors are indicated via a combination of LEDs that are on, off, or are blinking. Each LED combination has a meaning, indicating either a normal operation mode, or indicating an error.

Symbol	Meaning
	Permanent on
	Blinking
	Off

Overview of LED indications:

Operation mode	Bulk LED	Absorption LED	Float LED
Not charging ¹			
Bulk ¹			
Absorption ²			
Manual equalisation (alternating blinking) ²			
Automatic equalisation ²			
Float ²			

1. The bulk LED will blink briefly every 3 seconds when the system is powered but there is insufficient power to start charging.
2. The LED(s) might blink every 4 seconds indicating that the charger is receiving data from another device, this can be a GX device (ESS) or a VE.Smart Network link via Bluetooth

Fault mode	Bulk LED	Absorption LED	Float LED
Charger temperature too high			
Charger over-current			
Charger or panel over-voltage			
VE.Smart networking or BMS issue			
Internal error, calibration issue, settings data lost or current sensor issue.			

For the latest and most up-to-date information about the LED blink codes, refer to the Victron Toolkit app. The app is available for Apple and Android. The app can be downloaded from the respective app stores or alternatively follow the download links on our [software downloads page](#).

7.2. Error codes

In case of an error, an error code will be displayed via VictronConnect, a display, a GX device or on VRM. Each number corresponds with a specific error.

For a full list of error codes and their meaning see the appendix: [Charger error code overview](#)

7.3. Monitoring via the VictronConnect App

The VictronConnect App can be used to monitor the solar charger, see its historical values and if there are operational warnings or errors.

This chapter explains the solar charger specific VictronConnect App usage. Refer to the general [VictronConnect](#) manual for information about the VictronConnect App itself, such as: how to install the app, how to connect to the solar charger, how to update firmware and more.



Where battery voltage is referred in this chapter, a 12V battery is assumed.

To arrive at values for 24V, 36V or 48V batteries, multiply the 12V values by a factor of 2, 3 or 4 respectively.

7.3.1. VictronConnect status screen

The status screen displays the solar charger model name together with the live solar charger information.



Smart network

- The presence of the VE.Smart Network symbol  indicates that the solar charger is configured for VE.Smart Networking and is receiving battery temperature and/or battery voltage data from the VE.Smart Network.

Solar

- The solar gauge shows the solar output in relation to the maximum output power that the solar charger can generate at the set battery voltage and displays the dynamic real-time value of the solar array output power.
- The solar voltage measured at the solar terminals of the solar charger.
- The solar current flowing from the PV array into the solar charger.

Battery

- The battery voltage measured at the battery terminals of the solar charger.
- The current flowing from the solar charger into the battery.
- The battery state indicates the battery charge stage or if external control is active. These are the possible states:

Bulk

During this stage the solar charger delivers as much charge current as possible to rapidly charge the batteries. When the battery voltage reaches the absorption voltage setting, the solar charger activates the absorption stage.

Absorption

During this stage the solar charger switches to the constant voltage mode, where a pre-set absorption voltage is applied. When the charge current decreases below 2A or if the pre-set absorption time has elapsed, the battery is fully charged and the solar charger will enter the Float stage. Note that when an automatic equalisation is being performed this will also be reported as absorption.

Float

During this stage the float voltage is applied to the battery to maintain a fully-charged state. When the battery voltage drops below float voltage during at least 1 minute, a new charge cycle will be triggered.

External control

This will be displayed when another device is controlling the charge behaviour of the solar charger, bypassing its normal charge algorithm. Examples are when the solar charger is controlled by an ESS system or a managed battery.

- In case the charger is not charging a "Why is the charger off?" message will display. When clicking on this message, a new window will open with more information as to why the solar charger is not charging.



Virtual load output

- The state of the virtual load output, being switched on or switched off.

7.3.2. VictronConnect history screen

The history screen shows a summary of the data collected over the previous 30 days. Swipe the screen to the right or left to show any of the 30 days.



To switch between portrait or landscape screen presentation click the fragmented square icon,  or , at the top left of the screen.

The daily log shows:

- **Solar yield:** The energy (Wh) converted for that day.
- **Solar Pmax:** The maximum power (W) recorded during the day.
- **Solar Vmax:** The highest voltage (V) from the PV array during the day.
- **Battery max and min:** The first figure shows the maximum battery voltage (Vmax) for the day. The figure below is the minimum battery voltage (Vmin) for the day.
- **Errors:** This shows the daily number of errors, if any. To get more information about the error(s), click the orange dot. You may need to slide the display on your device up to see the errors.)
- **Lifetime total:** This shows the total energy converted by the installation (W and is not re-settable).
- **Since reset:** This shows how much energy has been converted by the installation since the last reset.

Clicking on any bar (day) in the graph will expand the information. It will show the time and percentage of the total charge time that the solar charger has spend in each Bulk, Absorption and Float charge stage.



You can use the charge times to see if the PV array is properly sized for your requirements. A system which never reaches the float stage may need more panels. Or perhaps the load should be reduced?

The history can be exported as a comma separated file (CSV) by clicking the three connected dots symbol or the save symbol at the top right of the history screen. The symbol varies, depending on what platform VictronConnect is used.

The history can be reset by clicking the clock with arrow symbol at the top right of the history screen.

7.3.3. VictronConnect error reporting

VictronConnect will indicate active errors while VictronConnect is actively connected to the solar charger. The error will show up in a pop-up window in the status screen together with the error number, name and a short error description.

VictronConnect also displays historical errors. To see these errors, navigate to the “History” tab and look at the bottom of each day column. If there is an error, an orange dot will indicate an error.



Active Error and Historical error

7.4. Monitoring via a GX device and VRM

If the solar charger is connected to a **GX device**, all its data can be accessed via the GX device. The GX device will also notify in case of solar charger alarms or faults.

For more information see the GX device manual.

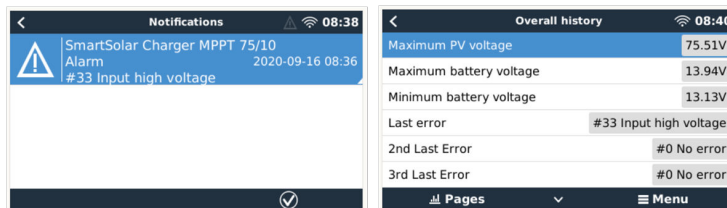

GX device showing alarm notification and historic errors.

If the GX device is connected to **Victron Remote Monitoring (VRM) portal**, the solar charger can be monitored remotely via the internet.

All solar charger data, alarms and errors can be accessed via the VRM portal and solar charger settings can be remotely changed via the VRM portal with the VictronConnect app.

Device	Triggered by	Description	Started at	Cleared after
Solar Charger [256]	Automatic monitoring	Error code: #33 - Input voltage too high	2020-09-16 08:36:18	6s

Solar charger alarm logging via VRM

8. Warranty

This product has a 5-year limited warranty. This limited warranty covers defects in materials and workmanship in this product and lasts for five years from the date of original purchase of this product. To claim warranty the customer must return the product together with the receipt of purchase to the point of purchase. This limited warranty does not cover damage, deterioration or malfunction resulting from alteration, modification, improper or unreasonable use or misuse, neglect, exposure to excess moisture, fire, improper packing, lightning, power surges, or other acts of nature. This limited warranty does not cover damage, deterioration or malfunction resulting from repairs attempted by anyone unauthorized by Victron Energy to make such repairs. Non-compliance with the instructions in this manual will render the warranty void. Victron Energy is not liable for any consequential damages arising from the use of this product. The maximum liability of Victron Energy under this limited warranty shall not exceed the actual purchase price of the product.

9. Troubleshooting and Support

Consult this chapter in case of unexpected behaviour or if you suspect a product fault.

The correct troubleshooting and support process is to first consult the common issues as described in this chapter.

Should this fail to resolve the issue, contact the point of purchase for technical support. If the point of purchase is unknown, refer to the [Victron Energy Support webpage](#).

9.1. The controller is not operational

For the controller to be operational it needs to be powered-up.

The controller will power up if a battery and/or a PV supply is present.

Once the controller is powered up, VictronConnect can be used to: check controller status, to check errors, to update firmware and/or to make or change settings.

Once powered up and operational, the controller LED(s) will illuminate or blink and is able to communicate with VictronConnect via Bluetooth (Smart models) or via the VE.Direct port (all models).

If the unit does not power up use this chapter to check the possible reasons why the controller is not operational.

9.1.1. Visual check

Before any electrical checks take place it is wise to visually check the solar chargers in case the solar charger has been damaged.

- Check for mechanical damage, burn marks or water damage. This damage is not normally covered by warranty.
- Inspect the battery terminals and the PV terminals. If there are burn marks on the terminals or if the cables or connectors are molten refer to paragraph: "PV cable connection burned or melted". In most cases this damage is not covered by warranty.
- Check if there are burn or melting marks on the housing or if there is a burn smell (all very unlikely). If this is the case, lodge a support request with your Victron dealer or distributor. Depending on the cause, this damage might not covered by warranty.

9.1.2. Battery supply check

Check if the solar charger is receiving battery supply.

The normal way to check the battery voltage is via the VictronConnect app, a display or a GX device. However, in this case the controller is not operational so the battery voltage needs to be measured manually. Measure the battery voltage at the solar chargers battery terminals using a multi meter.

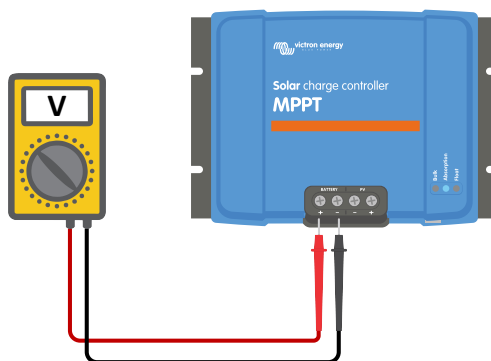

Measuring battery voltage at the battery terminals of the controller

The reason to measure the battery voltage at the terminals of the solar charger is to rule out potential issues with the wiring, fuses and/or circuit breakers located in the path between the battery and the controller.

Depending on the result of the measurement do the following:

Battery voltage	Operational state	Action to take
No voltage	Not powered	Restore the battery supply. See chapter: "battery supply issue"

Battery voltage	Operational state	Action to take
Correct voltage	Not powered	There might be a fault with the controller. Contact your Victron dealer or distributor.
Correct Voltage	Powered, but not charging	Connect PV supply and check if battery charging starts. If charging does not start, see chapter: "Batteries are not charged".

9.2. Batteries are not charged

This chapter lists all possible reasons why the solar charger does not charge the batteries, and the steps you can take to remedy the situation.

There are a number of reasons why the solar charger might not charge the batteries.

For example:

- Issues with the battery, PV panels or system wiring.
- Incorrect settings.
- The solar charger is externally controlled.
- Natural battery behaviour.

In some of these cases the VictronConnect app will show, at the bottom of the status screen, a clickable link with the text "why is the charger off". If the link is clicked, an explanation will appear as to why the charger is off.



VictronConnect – link to "why is the charger off"

9.2.1. Reverse battery polarity

Reverse polarity is when the positive and the negative battery cable have been accidentally swapped. The battery negative has been connected to the positive solar charger terminal and the battery positive has been connected to the negative solar charger terminal.

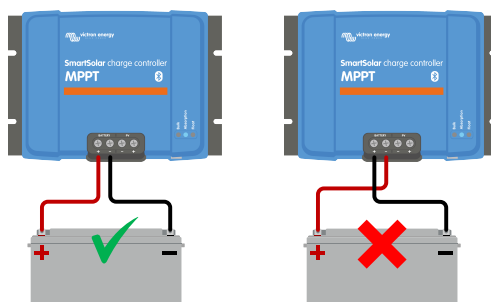

Examples of correct and incorrect (reverse) battery polarity



Be aware that a red cable or positive labelled cable might not necessarily mean that the cable is indeed a positive cable. A wiring or labelling mistake could have been made during installation of the solar charger.

The solar charger is not protected against reverse battery polarity and any damage caused by this is not covered under warranty.

Reverse battery polarity can in rare occasions be accompanied with a blown battery fuse (one that is located in the battery cable). But in most cases the ultra-fast internal fuse inside the solar charger will blow to ensure a proper fail-safe situation. This internal fuse will usually blow before the external fuse blows. The internal fuse is located in a non-serviceable area of the solar charger. It is not possible to replace or repair this fuse. This fuse will only blow in case of an internal fault, and replacing the fuse will not fix the internal fault.



Always verify the battery polarity before reconnecting the battery wires to the solar charger.

9.2.2. Reverse PV polarity

As long as the unit is installed within the published specifications, the PV input is protected internally against PV reverse polarity.

In case of reverse PV voltage, the solar charger will not indicate an error. The only way to tell is by the following signs:

- The controller is not charging the batteries.
- The controller is getting hot.
- The PV voltage is very low or zero Volt.

If this is the case check for reverse polarity using a multimeter by ensuring that the positive PV cable is connected to the positive PV terminal, and the negative cable is connected to the negative terminal.

9.2.3. Battery full

Once the battery is full the solar charger will stop charging or will greatly reduce the charge current.

This is especially the case when at the same time the DC loads in the system are not consuming any power from the battery.

To find out what the state of charge (SoC) of the battery is, check the battery monitor (if present), or alternatively check what charge stage the controller is in. Also observe that the solar cycle is (briefly) progressing through these charge stages at the beginning of the daily charge cycle:

- Bulk stage: 0-80% SoC
- Absorption stage 80-100% SoC
- Float or storage stage: 100% SoC.

Be aware that it can also be possible that the solar charger thinks the battery is full, while in reality the battery is not full. This can occur when the charge voltages have been set too low, causing the solar charger to prematurely switch to the absorption or float stage.

9.2.4. The charger is disabled

Check the VictronConnect app to make sure the charger has been enabled.



VictronConnect charger enable/disable setting

9.2.5. PV voltage too low

The solar charger will commence charging when the PV voltage is 5V higher than the battery voltage. Once charging has commenced, the PV voltage must remain 1V higher than the battery voltage for charging to continue.

Check the PV and battery voltage



WARNING: Depending on the solar charge controller model, the PV voltage can be up to 450Vdc. Voltages above 50V are generally considered to be dangerous. Check your local electrical safety regulations as to the exact regulations. Dangerous voltages can only be handled by a qualified technician.

1. Use the VictronConnect app, a solar charger display or a GX device to check the battery voltage and PV voltage.

Solar	
Voltage	72.00V
Current	55.5A
Battery	
Voltage	57.10V
Current	70.00A

- In case the above step is not possible, measure the battery and PV voltages at the solar charger terminals using a multi meter instead.

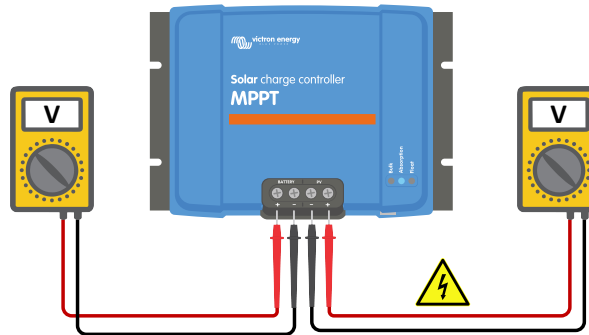

- Compare both voltages, the PV voltage needs to be 5V higher than the battery voltage for charging to commence.
-

Causes of zero or low PV voltage:

Not enough solar irradiance into the solar panels:

- Night.
- Cloud cover or bad weather.
- Shading – see this [shading blog story](#) for more information.
- Dirty panels.
- Seasonal differences.
- Wrong orientation and/or inclination.

Problems with a panel or panel wiring:

- Mechanical or electrical issue with an individual panel (or multiple panels).
- Wiring problems.
- Blown fuses.
- Open or faulty circuit breakers.
- Splitters or combiners issues, or these are used in an incorrect way.

PV array design issues:

- Solar array wiring configuration mistake - not enough panels in a series string.

Reverse PV polarity:

- The positive and negative have been swapped when connected to the controller, read next paragraph: “Reverse PV polarity”.

9.2.6. Battery voltage setting too low

The battery will not be charged if the “battery voltage” setting in the VictronConnect App is set at a voltage lower than the actual system voltage.

Check that the battery voltage is set properly in the settings of the solar charger. The battery voltage setting has to match that of the voltage of the battery.

To access the “battery voltage” setting, navigate to the controller settings in VictronConnect and then click on the “Battery” settings menu.

The “battery voltage” setting is listed at the top of the battery settings menu. Depending on controller model 12, 24, 36 or 48V can be selected.

In case the VictronConnect App is not available and a display is used, refer to the display manual on how to check or change this setting.



VictronConnect battery voltage setting

9.2.7. Controlled by an external device

The solar charger can be controlled by an external device. The external device can stop or reduce the charge current to the battery.

There are different types of external control:

- Managed batteries or an inverter/charger with an external control system can control the solar charger via a GX device. The battery dictates if charging is allowed, and when charging is allowed, what charge voltage and currents are used. If external control is active this will be displayed in the VictronConnect App and also on the GX device.

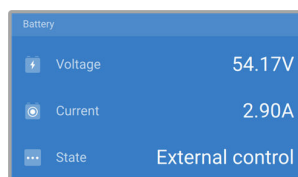

- The BMS of a managed battery can directly turn the charger on or off via a VE.Direct non-inverting remote on/off cable. This cable is connected to the VE.Direct port. The BMS can turn the charger off via this cable.

If the charge settings are correctly set and if all battery cells are balanced, the BMS should never disallow charging. The BMS will disallow charging when the cell voltage of one (or more) battery cells is too high or when the low temperature cut off is enabled and the battery temperature has dropped below the temperature threshold.

9.2.8. Battery supply issue

For the solar charger to be fully operational as a battery charger, it needs to be connected to a battery.

Although it might look like the solar charger is connected to the battery, it is very well possible that the controller is not receiving the battery supply, there is no voltage at the battery terminals of the solar charger.

Possible causes can be:

- Loose or missing battery cables.
- Loose cable connections, or badly crimped cable terminals.
- A blown (or missing) fuse in the battery supply cable.
- Open (or faulty) circuit breaker in the battery supply cable.
- Missing or incorrectly wired battery cables.

Battery voltage check

1. Use the VictronConnect app, a connected display or a GX device to find out what the battery terminal voltage of the controller is. If this is unavailable use a multi meter to measure the battery voltage at the terminals of the controller.

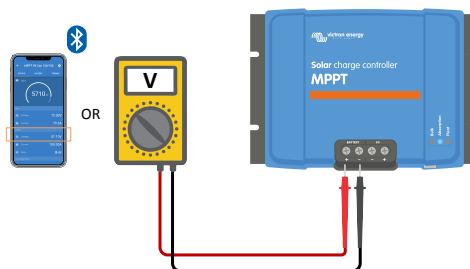

2. Use a multi meter to measure the voltage at the battery terminals.

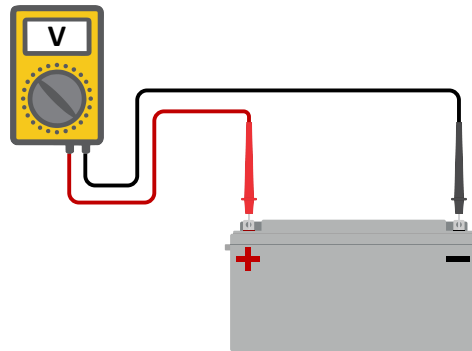

3. Compare the two voltages.
4. If the battery voltage and the controller voltage are not the same, then investigate why this is. Follow the path from the controller to the battery to investigate what could be the cause.

Battery supply check

1. Check and verify that all cabling is connected correctly, and that no wiring mistakes have been made.
2. Check if all cable connections are tight while taking maximum torque levels into consideration.
3. Check if all cable lugs or cable terminals have been crimped correctly.
4. Check fuses and/or circuit breakers.



If a blown fuse is found, first ensure that the battery polarity has been correctly wired before replacing the fuse. See next paragraph for more information on reverse battery polarity.

9.2.9. PV voltage too high

The PV voltage should never exceed the maximum rated PV voltage of the solar charger. The maximum PV voltage rating is printed on the front or on the side of the housing of the controller, and in the product specification sheets.

The solar charger stops charging if the PV voltage exceeds the maximum rated PV voltage. At the same time, it will display an overvoltage error #33, and will fast blink its absorption and float LED.

Charging will not recommence until the PV voltage has dropped 5V below the rated maximum voltage.

When investigating a high voltage issue, also look at the history of the VictronConnect app, solar charger display or GX device. Check the highest PV voltage for each day (Vmax) and also look for past overvoltage warnings.

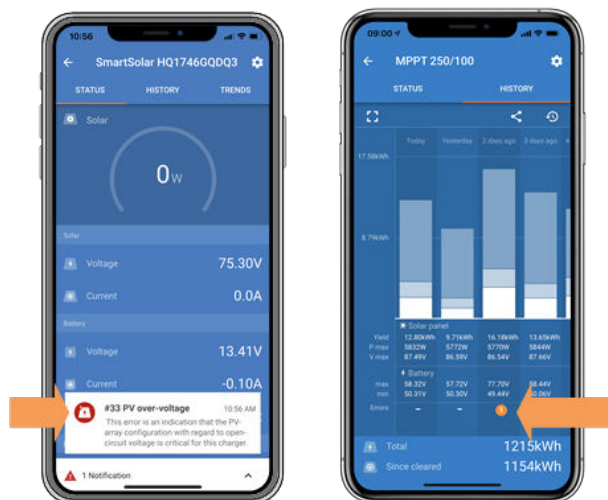

VictronConnect: screenshot of an Error #33 and a screenshot of the history indicating an error

Check the open circuit voltage (Voc) rating of the PV array. Ensure that it is less than the maximum rated voltage of the solar charger. Use the MPPT sizing calculator on the [solar charger product page](#). In case the PV array is located in cold climates or if the night temperature drops close to or below 10°C the PV array can output more than its rated Voc. As a rule of thumb, keep an additional 10% safety margin.

An overvoltage event can damage the solar charger, depending on how much the maximum PV voltage was exceeded. This damage is not covered by warranty.

9.3. Batteries are undercharged

This chapter deals with possible reasons why the solar charger is not sufficiently charging the batteries and the steps you can take to check or remedy the situation.

Some signs of undercharged batteries:

- The batteries take too long to charge.
- The batteries are not fully charged at the end of the day.
- The charge current from the solar charger is less than expected.

9.3.1. Too much DC load

The solar charger does not only charge the batteries, it also provides power for the system's loads.

The battery will only be charged when the power available from the PV panels exceeds the power being drawn by the loads in the system, like lights, fridge, inverter, and so on.

If the system battery monitor is correctly installed and configured you can see how much current is going in (or out) of the battery and the solar charger will tell you how much current the solar array is generating.

A positive sign alongside the current reading means that current is flowing in to the battery, while a negative sign means that current is being drawn from the battery.

9.3.2. Battery charge voltages are too low

If the battery voltages have been set too low the batteries will not receive a full charge.

Check if the battery charge voltages (absorption and float) are set correctly. Consult the battery manufacturers information for the correct charge voltages.

9.3.3. The battery is almost full

The solar charger will reduce its charge current when the battery is almost full.

If the state of charge of the battery is unknown, and the current is reducing while the sun is still shining, it can mistakenly be interpreted as the solar charger being faulty.

The first current reduction takes place at the end of the absorption stage, when the battery is approximately 80% charged.

The current will continue to reduce during the float stage, when the battery is approximately 80 and 100% charged.

The float stage starts when the batteries are 100% full. During the float stage the charge current is very low.

To find out what the state of charge (SoC) of the battery is, check the battery monitor (if present), or alternatively check the charge stage the solar charger is in.

- Bulk: 0-80% SoC
- Absorption 80-100% SoC
- Float or storage: 100% SoC

9.3.4. Battery cable voltage drop

If there is a voltage drop over the battery cables, the solar charger will output the correct voltage, but the batteries will receive a lower voltage. Battery charging will take longer, and this can potentially lead to undercharged batteries.

A VE.Smart network can help in case of a cable voltage drop. A [Smart Battery Sense](#) or battery monitor measures the battery terminal voltage and sends this via the VE.Smart network to the solar charger. If the battery voltage is less than the solar charge voltage, the solar charger will increase its charge voltage to compensate for the voltage losses. But be aware that in case there is a large voltage drop, the battery cables and cable connection will need to be checked and if there are issue they will needs to be rectified first.

A voltage difference has the effect that the battery will be charged with voltages that are too low to. It will take longer to charge the batteries because the charge voltage is too low and there is a loss of charge power. The lost power is caused by heat dissipated over the battery cables.

The voltage drop is caused by the following:

- Battery cables with insufficient cross-sectional area
- Badly crimped cable lugs or terminals
- Loose terminal connections
- Bad or loose fuse(s)

For more information on cabling issues and voltage drop see the [Wiring unlimited book](#)

Battery cable voltage drop check

This check can only be performed if the solar charger is in the bulk charge stage and is charging with full current.

1. Measure the voltage on the battery terminals of the solar charger using the VictronConnect app or a multi meter.

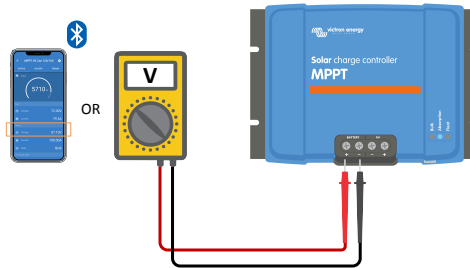

2. Measure the battery voltage on the terminals of the battery using a multi meter.

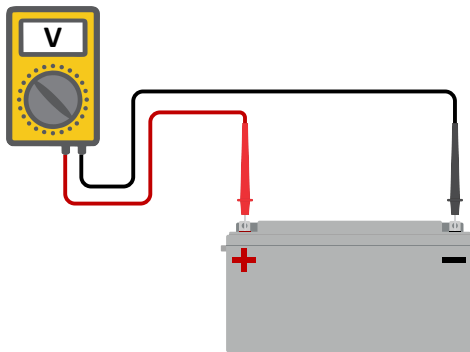

3. Compare the two voltages to see if there is a voltage difference.

9.3.5. Temperature difference between solar charger and battery

It is important that the ambient temperatures of the battery and the controller are equal if the solar charger is not receiving battery temperature data.



This chapter does not apply if the solar charger is connected to a VE.Smart Network with a battery temperature measurement or is equipped with a temperature sensor.

The solar charger will measure ambient temperature at the beginning of the day, as soon as power is generated by the solar array.

It will temperature compensate the charge voltage according to this temperature measurement.

Once the solar charger goes into the float stage it will measure the ambient temperature again and will use that measurement to adjust the voltages again.

If there are large ambient temperature difference between solar charger and battery, the battery will be charged at the wrong voltages.

An example of this is if the solar charger is located near a window in the sun, and the batteries are located on a cold concrete floor in the shade.

Always make sure that the ambient conditions are equal for both the solar charger and the battery.

9.3.6. Insufficient solar

Check if the solar charger reaches the float charge stage each day.

To investigate look at the history tab in the VictronConnect app. The histogram displays how long the batteries have been charged in the Bulk, Absorption and Float stage each day, for the last 30 days. If you click on one of the histogram columns you will see a breakdown of the charge stages.

You can use the charge times to see if the PV array is properly sized for your requirements. A system which never reaches the float stage could have the following issues:

- Not enough solar panels
- Too much load
- A problem with the array causing it to have a reduced power output.
- For more potential reasons see paragraph: "PV power or yield less than expected"

Please note that above information does not apply to an ESS system. An ESS system will always be in the bulk charge stage while grid is connected.

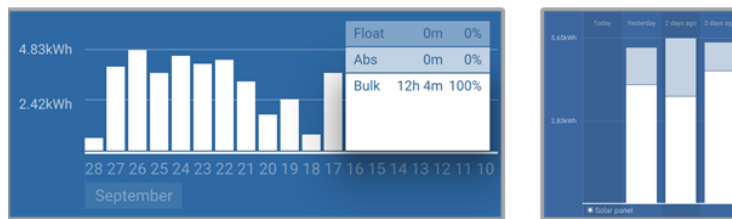

System spending all its time in bulk with breakdown of charge stages - System in bulk and absorption

9.3.7. Wrong temperature compensation setting

If the temperature compensation coefficient is set incorrectly, the batteries can be undercharged or be overcharged. The temperature compensation can be set via VictronConnect or via a display.

To find out the correct temperature compensation coefficient setting for your battery, refer to the battery documentation. When in doubt use the default value of $-64.80\text{mV}/^{\circ}\text{C}$ for lead acid batteries and disable the temperature compensation setting for lithium batteries.

9.3.8. Battery charge current too low

Check the "Max charge current" setting in the VictronConnect app or via the display.

If the "Max charge current" has been set too low, it will take longer to charge the batteries and/or the batteries will not be fully charged at the end of day.

9.4. Batteries are overcharged



Batteries that are being overcharged are very dangerous! There is a risk of battery explosion, fire or acid leakage. Do not smoke, create sparks or have open flames in the same room as where the batteries are located.



Overcharging batteries will cause battery damage and can be caused by:

- Incorrect charge voltage settings.
- Battery voltage setting too high.
- Applying equalization while the battery is not suitable for equalization.
- High current and undersized batteries.
- Battery faults.
- Too high current, while the battery is not accepting charge anymore because of aging or prior mistreatment.

9.4.1. Battery voltage setting too high

If the "battery voltage" setting in the VictronConnect App has been set to a voltage higher than the actual system voltage, the battery will be overcharged.

The solar charger automatically detects the battery voltage on first install and after the self-detection is disabled. This can become a problem if a solar charger that came out of a 24V system is now used in an 12V system.

In that scenario it will not detect that the system has changed and will keep charging with 24V battery charge voltages, while the connected battery is a 12V battery and the 12V battery will be overcharged.

Some background on why this is: In the very early days, the solar charger would always automatically detect the battery voltage, but this was problematic in case the battery was disconnected often, for example by a BMS. This feature has since been changed to detect the voltage only once on first install.

To check the “battery voltage” setting use the VictronConnect App or a connected display. If set incorrectly, set it to the correct battery voltage.

9.4.2. Battery charge voltages too high

If the battery charge voltages are set too high this will cause the batteries to overcharge.

Check if all the battery charge voltages (absorption and float) are set correctly.

The charge voltages have to match the recommended voltages as stated in the battery manufacturers documentation.

9.4.3. Battery unable to deal with equalization

During equalization the battery charge voltage will be quite high and if the battery is unsuitable to be equalized, the battery will be overcharged.

Not all batteries can be charged with equalization voltages. Check with the battery manufacturer if the battery you are using needs a periodic equalizing charge.

Generally speaking, sealed batteries and lithium batteries cannot be equalized.

9.4.4. Battery old or faulty

A battery that is at the end of its service life or has been damaged by incorrect use, can be prone to being overcharged.

A battery contains a number of cells that are connected in series. When a battery is old or has been damaged, a likely scenario is that one of these cells is not operational anymore.

When the faulty battery is charged, the damaged cell will not accept charge and the remaining cells will receive the broken cell's charge voltage and thus will be overcharged.

To fix this, replace the battery. In case of multiple battery system replace the whole battery bank. It is not recommended to mix batteries of different ages in one battery bank.

It is hard to tell what has exactly happened to a battery during its lifetime. The solar charger will keep 30 day of battery voltage history. If the system also contains a battery monitor, or if the system is connected to VRM, the battery voltages and the cycle history of the battery can be accessed. This will give a complete picture of the battery history and it can be determined if the battery is near the end of its service life or has been abused.

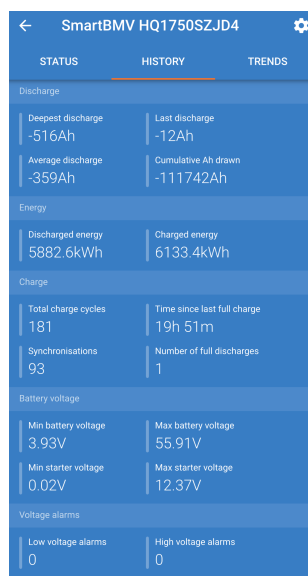

VictronConnect app showing BMV battery monitor history

To check if the battery is close to its cycle life:

1. Find out how many charge and discharge cycles the battery has been subjected to. Battery lifetime correlates to the number of cycles.
2. Check how deep the battery has been discharge on average. A battery will last for less cycles if deeply discharged, compared to more cycles if discharged less deep.
3. Refer to the battery data sheet to find out how many cycles at what average discharge the battery is capable of. Compare this with the battery history and determine if the battery is near the end of its service live.

To check if the battery has been misused:

1. Check if the battery has been totally discharged at all. Total and very deep discharge will damage a battery. Check the battery monitor setting history on the VRM portal. Look for the deepest discharge, the lowest battery voltage and the number of full discharges.
2. Check if the battery has been charged with a too high voltage. Very high charge voltage will damage the battery. Check the maximum battery voltage and the high voltage alarms in the battery monitor. Check if the measured maximum voltage has exceeded the battery manufacturer recommendations.

9.5. Solar issues

This chapter deals with the remaining potential solar issues that were not already discussed in the earlier chapters.

9.5.1. PV reverse current too high

Overcurrent does not necessarily damage the solar charger, but it will cause damage if the array produces too much current while, at the same time, the array has been connected in reverse polarity to the solar charger. Damage due to overcurrent is not covered under warranty.

Refer to the solar chargers technical specifications for the maximum PV short circuit power current rating.

9.5.2. PV yield less than expected

Check the solar charger history in the VictronConnect app. Check the total maximum power (Pmax) for each day. Does this match the array power?

To find the potential solar yield per day for a specific PV array size in a specific geographical location, use the MPPT sizing calculator on the [solar charge controller product page](#).

These are some of the reasons why the array is generating less power than expected:

- Low sun angle, seasonal differences or morning/evening.
- Cloud cover or bad weather.
- Shading from trees or buildings.
- Dirty panels.
- Incorrect orientation and/or inclination.
- Broken or faulty solar panel(s).
- Issues with wiring, fuses, circuit breakers, wiring voltage drop.
- Bad splitters or combiners, or these are used in an incorrect way.
- Part of the PV array not working.
- PV array design issues.
- Solar array configuration mistakes.
- The batteries are too small, or getting older, and have a reduced capacity.

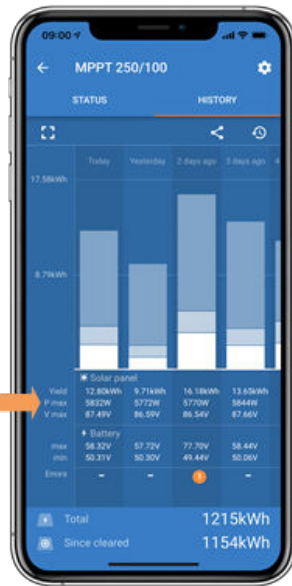

VictronConnect history Pmax

9.5.3. Full rated output not reached

There are a few reasons why the solar charger is not reaching its full rated output.

Some of these reasons have already been explained in the the chapter: "The batteries take too long to charge, are undercharged or charge current less than expected". Some additional reasons are explained in this paragraph.

PV array too small

If the PV array power rating is less than the solar charger nominal power rating, the solar charger cannot output more power than the connected solar array can provide.

Temperature above 40°C

When the solar charger heats up, eventually the output current will derate. When the current is reduced naturally the output power will reduce as well.

The controller is operational up to 60°C, with a full rated output up to 40°C.

In case the solar charger heats up quicker than expected, pay attention to the way it has been mounted. Mount it in such a way that the generated heat can dissipate.

Ideally mount the solar charger on a vertical surface with the terminals facing downwards.

If the solar charger is located in a closed enclosure, such as a cabinet, make sure that cold air can enter and hot air can leave the enclosure. Mount vents in the enclosure.

For very hot environments consider mechanical air extraction or provide air conditioning.

9.5.4. Max PV output power relates to battery voltage

The output current of the solar charger is current limited to its rated current. This means that the output power will vary, depending on the voltage of the battery.

For example:

A 75/15 solar charger has an output current rating of 15A. This is the current that is going into the battery. This means that if the solar charger is connected to a 12V battery you will get less power into your battery than with a 24V battery.

- For a 12V battery this is $15A \times 12V = 180W$.
- For a 24V battery this is $15A \times 24V = 360W$.

So, although a 360 W panel is connected to the solar charger, it will not be able to output the same power into a 12V battery than it will when connected to a 24V battery.

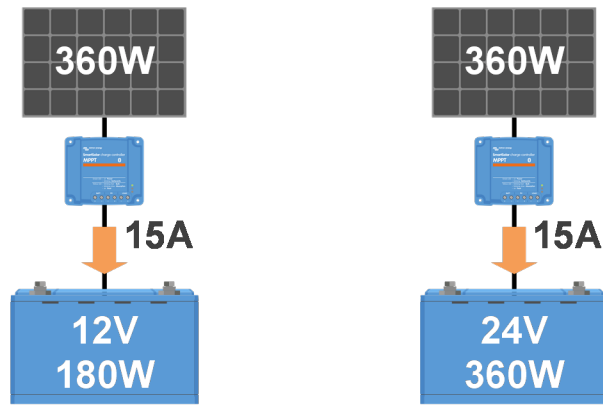

Example of differences in output power at different battery voltages

9.5.5. Mixed PV panel types

It is not recommended to connect a mix of different PV panel types to the same solar charger.

Only use solar panels that are the same brand, type and model.

9.5.6. PV connections burned or melted

Burned or melted PV cables or connections are generally not covered under warranty. In most case this is due to any of the following reasons:

Solar cable

- Cables with rigid core wire or rigid strands used.
- Cables where the core wire has been soldered.
- Cable too thin - remember that the current will be higher when the PV voltage is lower. For more information on cable thickness see the [Wiring Unlimited book](#).

Screw terminals

- Loose screw connection.
- Cable insulation inserted too deep into the connector.
- Cables with rigid core wire or rigid strands used.
- Cables where the core wire has been soldered.

9.5.7. MC4 connectors wrongly connected

For a detailed explanation on how to connect MC4 connectors, MC4 splitters and MC4 combiners, see the [Wiring unlimited book](#), chapter 4.10: "Solar panels".

9.5.8. Optimisers cannot be used

Do not use solar panels with optimisers together with the solar charger.

Nearly all optimisers contain an MPPT or other tracking mechanisms and this interferes with the MPPT algorithm in the solar charger.

9.5.9. Earth fault detection missing

This solar charger is not equipped with an earth fault relay or an earth fault warning circuit. Use an external ground fault relay or ground fault detector.

9.5.10. Ground current

The system should not have a current flowing to ground under normal operation.

If a ground current is detected, first investigate all the equipment connected to that system and check for ground faults.

Next, check how many connections to ground the system has. There should only be a single point in the system connected to ground. This should be at the battery.

For more information on system grounding, see chapter 7.7: "System grounding" in the [Wiring Unlimited book](#).

The solar charger is non-isolated, the minus of the PV input is at the same potential as the minus of the battery output.

9.6. Communication issues

This chapter describes issues that might arise when the solar charger is connected to the VictronConnect app, other Victron devices or third-party devices.

9.6.1. VictronConnect issues



For a full troubleshooting guide on the VictronConnect app see the [VictronConnect manual](#).

9.6.2. VE.Direct port communication issues

These are not common and if this occurs it is probably due to one of these issues listed in this paragraph.

Physical cable connector or data port issues Try a different VE.Direct cable and see if the unit will now communicate. Is the connector inserted properly and deep enough? Is the connector damaged? Inspect the VE.Direct port, are there bent pins? If this is the case, use long nose pliers to straighten the pins, while the unit is unpowered.

VE.Direct communication issues To check if VE.Direct communication is operating correctly, connect the solar charger to a GX device and check if the controller shows up on the GX device's list. If it does not show up, check that TX port function in VictronConnect is set to "Normal communication".

VE.Direct TX port issues Check the "TX port function" setting in VictronConnect. Does the set function match the application it is being used in. To test if the TX port is operational check its functionality using a [TX digital output cable](#).

VE.Direct RX Port issues Check the "RX port function" setting in VictronConnect. Does the set function match the application it is being used in. To test if the RX port is operational check its functionality using a [VE.Direct non-inverting remote on/off cable](#).

9.6.3. VE.Smart communication issues

A VE.Smart Network is a wireless communication network between several Victron products using Bluetooth. In case of issues with a VE.Smart Network refer to the [Smart Network manual](#).

9.6.4. Bluetooth issues

Please note that it is highly unlikely that the Bluetooth interface is faulty. The problem is most likely caused by something else. Use this chapter to quickly rule out some of the common causes of Bluetooth issues.

For a full troubleshooting guide see the [VictronConnect manual](#).

- **Check if the solar charger is equipped with Bluetooth**

Only SmartSolar models have built-in Bluetooth, the BlueSolar models do not. If the model does not have built-in Bluetooth, a [VE.Direct Bluetooth Smart dongle](#) or [VE.Direct to USB interface](#) can be used.

- **Check if Bluetooth is enabled**

It is possible to enable/disable Bluetooth in the product settings. To re-enable:

Connect to the solar charger via the VE.Direct port.

Navigate to the controller settings and then to "product info".

Re-enable Bluetooth.

- **Check if the controller is powered-up**

Bluetooth is active as soon as the solar charger is powered-up.

- **Check that Bluetooth is in range**

In open space the maximum Bluetooth distance is about 20 meters. In a build-up area, inside a house, a shed, a vehicle or a boat this distance can be a lot less.

- **The Windows VictronConnect app does not support Bluetooth**

The Windows version of the VictronConnect app does not support Bluetooth. Use an Android, iOS or macOS device instead. Or alternatively connect using a [VE.Direct to USB interface](#).

- **The controller is missing in the VictronConnect device list**

Some steps to try to resolve this issue are:

Press the orange refresh button at the bottom of the VictronConnect device list and check if the solar charger is now listed. Only one phone or tablet can be connected to the solar charger at any given time. Make sure no other devices are connected and try again.

Try to connect to another Victron product, does this work? If that also does not work, there probably is an issue with the phone or tablet.

Rule out any issues with the phone or the VictronConnect app by using another phone or tablet and try again.

If still unresolved, refer to the [VictronConnect manual](#).

- **PIN code lost**

If you have lost the PIN code, you will need to reset the PIN code to its default PIN code. This is done in the VictronConnect app:

Navigate to the device list of the VictronConnect app.

Enter the solar charger's unique PUK code as printed on its product information sticker.

Click on the option symbol next to the solar charger listing.

A new window will open which allows you to reset the PIN code back to its default: 000000.

- **How to communicate without Bluetooth**

In case Bluetooth is not functional, turned off or unavailable, VictronConnect can communicate via the unit's VE.Direct port. Or, if the unit is connected to a GX device, VictronConnect can communicate via VRM. For more information see paragraph: "The different ways to connect with VictronConnect".

9.7. Settings or firmware issues

9.7.1. Incorrect settings

Incorrect settings can cause strange solar charger behaviour. Check if all settings are correct.

If in doubt, it could be an option to reset all settings to default using the VictronConnect app and then make all required settings. Consider saving the existing settings before performing a reset.

In most cases the default setting can be used with only minor changes.



If help is required with making settings, please refer to the manual or contact your Victron supplier or distributor.

9.7.2. Firmware issues

To rule out a firmware bug, update the firmware.

NOTE: It might be useful to write down the firmware number before and after the update. This can be useful information should you need to request [support](#).

On first connection, the controller might have updated the firmware. If the controller did not automatically ask for a firmware update, check if the controller is running the most up to date firmware and perform a manual update:

- Connect to the controller.
- Click on the settings symbol .
- Click the option symbol .
- Go to product info.
- Check if you are running the latest firmware and look for the text: "This is the latest version".
- If the controller does not have the most up to date firmware, perform a firmware update by pressing the update button.

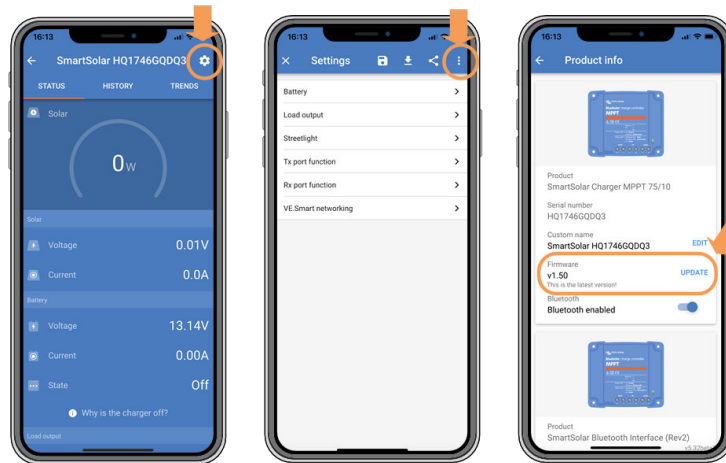

Status screen - Settings screen - Product info screen

9.7.3. Interrupted firmware update

This is recoverable and is nothing to worry about. Just try to update the firmware again.

9.8. Operation issues

This chapter describes all remaining troubleshooting suggestions that were not covered in previous chapters.

9.8.1. Unable to operate as a power supply

We do not recommend to use the solar charger as a power supply, that is without batteries connected.

Operation as a power supply will not damage the solar charger, but it is not guaranteed that the solar charger is able to run all types of loads. Some type of loads might run, others might not. Especially at low load power, the solar charger is too slow to keep the voltage constant. As such, we do not provide support in these kind of situations.

9.8.2. Unable to operate as a DC to DC charger

It is not recommended to use the solar charger as a DC/DC charger, for example, to charge a 12 Volt battery from a 24V battery bank.

Connecting a battery to the PV terminals can, under certain operational conditions, cause damage to the solar charger. This damage is not covered by warranty.

10. Technical specifications

10.1. Specifications 150/35 and 150/45

	MPPT 150/35	MPPT 150/45
Battery voltage	12V / 24V / 48V Auto select, 36V: Manual select	
Maximum battery current	35A	45A
Nominal PV power, 12V ^{1a,b}	500W	650W
Nominal PV power, 24V ^{1a,b}	1000W	1300W
Nominal PV power, 36V ^{1a,b}	1500W	1950W
Nominal PV power, 48V ^{1a,b}	2000W	2600W
Max. PV short circuit current ²	35A	45A
Maximum PV open circuit voltage	150V	
Peak efficiency	98%	
Self-consumption	12V: 20mA / 24V: 15mA / 48V: 10mA	
Charge voltage 'absorption'	Default setting: 14.4V / 28.V / 43.2V 57.6V (adjustable)	
Charge voltage 'float'	Default setting: 13,8V / 27,6V 14.4V / 55,2V (adjustable)	
Charge voltage 'equalization' ³⁾	Default setting: 16.2V / 32.4V / 48.6V / 64.8V (adjustable)	
Charge algorithm	Multi-stage adaptive (eight pre-programmed algorithms) or user defined algorithm	
Temperature compensation	-16mV/°C / -32mV/°C / -64mV/°C	
Protection	PV reverse polarity, output short circuit, over-temperature	
Operating temperature	-30°C to +60°C (full rated output up to 40°C)	
Humidity	95%, non-condensing	
Maximum altitude	5000m (full rated output up to 2000m)	
Environmental condition	Indoor type 1, unconditioned	
Pollution degree	PD3	
Data communication	VE.Direct ⁴	
ENCLOSURE		
Colour	Blue (RAL 5012)	
Power terminals	16mm ² / AWG6	
Protection category	IP43 (electronic components), IP22 (connection area)	
Weight	1.25kg	
Dimensions h x w x d	130 x 186 x 70 mm	
STANDARDS		
Safety	EN/IEC 62109-1/ UL 1741 / CSA C22.2 NO.107.1-16	
<p>1a) The solar charger will limit input power if more PV power is connected.</p> <p>1b) The PV voltage must exceed Vbat + 5V for the controller to start. Thereafter the minimum PV voltage is Vbat + 1V.</p> <p>2) A higher short circuit current may damage the solar charger in case of reverse polarity connection of the PV array.</p> <p>3) Equalization is by default disabled.</p> <p>4) For more information on data communication see the data communication paper in the Technical information section on our website.</p>		

11. Appendix

11.1. Dimensions 100/35 and 150/45

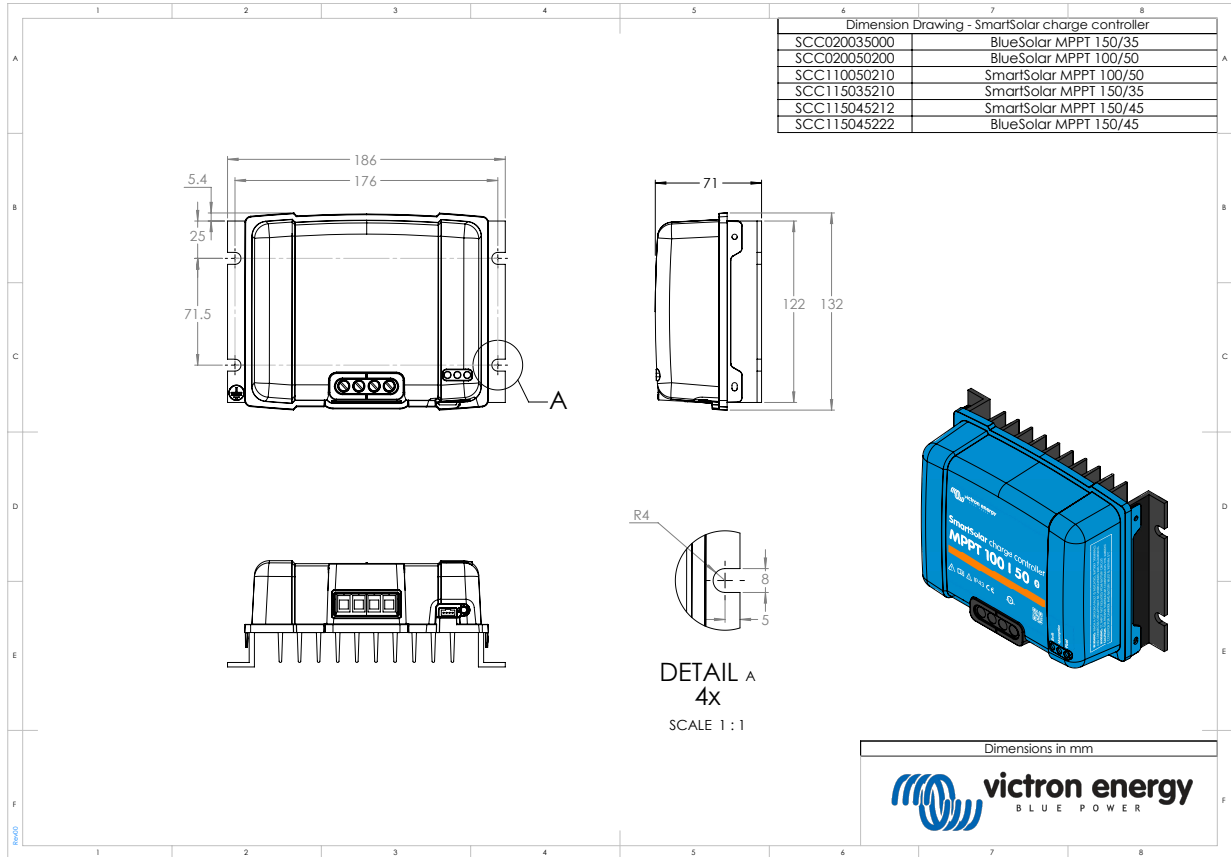

11.2. Charger error code overview

This overview lists all possible error codes that can be generated by a solar charger or AC charger.

The error codes are displayed on the charger display, remote display or via a connected GX device.



Note that not all of these errors might apply to your charger model. Some error types only apply for solar chargers, for AC chargers or are specific only to certain models within a charger group.

Error 2 - Battery voltage too high

The battery voltage is higher than expected. This error can be due to other charging equipment connected to the battery or a fault in the charger. This error can also occur if the battery voltage (12, 24, 36 or 48V) is set to a lower voltage than the connected battery. This error will auto-reset after the battery voltage has dropped.

Error 3 and/or 4 - Remote temperature sensor failure

Check if the T-sense connector is properly connected to a remote temperature sensor. Most likely cause: the remote T-sense connector is connected to the BAT+ or BAT- terminal. This error will auto-reset after proper connection.

Error 5 - Remote temperature sensor failure (connection lost)

Check if the T-sense connector is properly connected to a remote temperature sensor. This error will not auto-reset.

Error 6 and/or 7 - Remote battery voltage sense failure

Check if the V-sense connector is properly connected to the battery terminals. Most likely cause: the remote V-sense connector is connected in reverse polarity to the BAT+ or BAT- terminals.

Error 8 - Remote battery voltage sense failure (connection lost)

Check if the V-sense connector is properly connected to the battery terminals.

Error 17 - Controller overheated despite reduced output current

This error will auto-reset after charger has cooled down. Check the ambient temperature and check for obstructions near the heat sink.

Error 18 - Controller over-current

This error will auto-reset. If the error does not auto-reset disconnect the charger from all power-sources, wait 3 minutes, and power up again. If the error persists the charger is probably faulty. A cause for this error can be switching on a very large load on the battery side.

Error 20 - Maximum Bulk-time exceeded

For solar chargers:

The maximum bulk time protection is a feature that was in the chargers when they were just released (2015 or earlier) and later the feature was removed.

If you do see this error, then update to the latest firmware.

If you then still have the error, perform a reset to factory defaults of the configuration, and reconfigure the solar charger.

For AC chargers:

This protection is by default enabled on the Skylla-i and the Skylla IP44.

This error is generated when the battery-absorption-voltage is not reached after 10 hours of charging.

The feature of this safety protection is to detect a shorted cell; and stop charging.

Error 21 - Current sensor issue

The current measurement is out of range.

Disconnect all wires, and then reconnect all wires, to make the charger restart. Also, make sure the minus on the MPPT charge controller (PV minus/Battery minus) is not bypassing the charge controller.

This error will not auto-reset.

If the error remains, please contact your dealer, there might be a hardware defect.

Error 24 - Fan failure

This error indicates that the fan is powered on but the circuit does not measure any current draw by the fan. Most likely its either broken or obstructed.

Please contact your dealer, there might be a hardware defect.

Error 26 - Terminal overheated

Power terminals overheated, check wiring, including the wiring type and type of strands, and/or fasten bolts if possible.

This error will auto-reset.

Error 28 - Power stage issue

This error will not auto-reset.

Disconnect all wires, and then reconnect all wires. If the error persists the charger is probably faulty.

Note that this error was introduced in v1.36. So when doing an update, it might look like the firmware update caused this issue; but it doesn't. The solar charger was then already not performing 100% before the update; updating to v1.36 or later merely made the issue more visible. The unit needs to be replaced.

Error 33 - PV over-voltage

This error will auto-reset after PV-voltage has dropped to safe limit.

This error is an indication that the PV-array configuration with regard to open-circuit voltage is critical for this charger. Check configuration, and if required, re-organise panels.

Error 34 - PV over-current

The current from the solar-panel array has exceeded the maximum allowed current.

This error could be generated due to an internal system fault.

Disconnect the charger from all power-sources, wait 3 minutes, and power-up again. If the error persists the controller is probably faulty, contact your dealer.

Error 38 and/or 39 - PV Input shutdown

To protect the battery from over-charging the PV input is shorted.

Possible reasons for this error to occur:

- The Battery voltage (12/24/48V) is set, or auto-detected, incorrectly. Use VictronConnect to disable auto-detect and set the Battery Voltage to a fixed voltage.
- There is another device connected to the battery, which is configured to a higher voltage. For example a MultiPlus, configured to equalise at 17 Volts, while in the MPPT this is not configured.
- The battery is disconnected using a manual switch. Ideally the charger should be switched off before disconnecting the battery, this avoids a voltage overshoot on the charger output. If necessary the voltage trip-level for the PV Short protection can be increased by raising the Equalization voltage set-point (note: equalization does not have to be enabled in this case).
- The battery is disconnected using a Lithium charge relay connected to the "allow-to-charge" output of a BMS. Consider wiring this signal to the Remote terminal of the charger instead. This shuts down the charger gracefully without creating a voltage overshoot.

Error recovery:

- Error 38: First disconnect the solar panels and disconnect the battery. Wait for 3 minutes, then reconnect the battery first and next the panels.
- Error 39: The charger will automatically resume operation once the battery voltage drops below its maximum voltage setting (normally Equalisation or Absorption voltages), for 250V versions or float voltage for the other units. It can also takes a minute to reset the fault.

If the error persists the charge controller is probably faulty.

Error 40 - PV Input failed to shutdown

If the charger is unable to turn off the PV input, it will go into a safe mode in order to protect the battery from over-charging or having a high voltage on the battery terminals. In order to do that, the charger will stop charging and disconnect its own output. The charger will become faulty.

Information 65 - Communication warning

Communication with one of the paralleled chargers was lost. To clear the warning, switch the charger off and back on.

Information 66 - Incompatible device

The charger is being paralleled to another charger that has different settings and/or a different charge algorithm. Make sure all settings are the same and update firmware on all chargers to the latest version.

Error 67 - BMS Connection lost

The charger is configured to be controlled by a BMS, but it does not receive any control messages from a BMS. The charger stopped charging, as a safety precaution.

This error only shows when there is solar power available and thus the charger is ready to initiate charging. It does not show at night. In case there is a permanent problem, the error will raise in the morning and clear at night, and so forth.

Check the connection between the charger and the BMS.

How to reconfigure the charger to standalone mode:

The charger automatically configures themselves to be BMS-controlled when they are connected to one; either direct or via a GX Device. And that setting is semi-permanent: power cycling the charger will not reset it.

Here is what needs to be done to make the charger operate in stand-alone mode again, ie. not controlled by a BMS:

- VE.Can solar chargers, go into the setup menu, and change setting 'BMS' from 'Y' to 'N' (setup item 31).
- VE.Direct solar chargers, reset the charger to factory defaults with VictronConnect, and then reconfigure it.

Error 68 - Network misconfigured

Applies to SmartSolar/BlueSolar chargers VE.Can (FW version v1.04 or higher) and SmartSolar VE.Direct chargers (FW version v1.47).

To clear the error on the SmartSolar VE.Direct chargers update the FW version to v1.48 or higher.

To clear the error on the SmartSolar/BlueSolar chargers VE.Can, update the software. If the error persists, it will be because the charger is connected with both a VE.Direct cable and on VE.Can. That is not supported. Remove one of the two cables. The error will disappear and the charger will resume normal operation, within a minute.

Background:

Error 68 indicates that the charger detects multiple conflicting network sources, with the same priority, trying to send the same information to the charger. VE.Can and VE.Direct interfaces have both the same priority level, and BLE (using VE.Smart Networking) has a lower priority.

Having a higher priority level means that, if the same information (e.g. Battery voltage sense) is being received from both VE.Can and BLE (using VE.Smart Network) by the charger, the information on VE.Can will be used and the one coming from BLE will be ignored.

Now, if the same information is being received from two interfaces that have the same priority level (as VE.Can and VE.Direct), the charger does not know how to prioritize those, causing error 68 to be triggered.

Error 114 - CPU temperature too high

This error will reset after the CPU has cooled down. If the error persists, check the ambient temperature and check for obstructions near the air inlet and outlet holes of the charger cabinet. Check manual for mounting instructions with regard to cooling. If error persists the controller is probably faulty.

Error 116 - Calibration data lost

If the unit does not work and error 116 pops up as the active error, the unit is faulty. Contact your dealer for a replacement.

If the error is only present in the history data and the unit operates normally this error can be ignored safely. Explanation: when the units power up for the very first time in the factory, it does not have calibration data and an error 116 is logged. Obviously this should have been cleared, but in the beginning units left the factory with this message still in the history data.

SmartSolar models (not the BlueSolar models): upgrading to v1.4x firmware is a one-way trip, you cannot go back to an older firmware version once you upgrade to v1.4x. Reverting to older firmware gives error 116 (calibration data lost), this can be fixed by re-installing the v1.4x firmware.

Error 119 - Settings data lost

The charger cannot read its configuration, and stopped.

This error will not auto-reset. To get it working again:

1. First, restore it to factory defaults. Click on the three dots  located in the top right in VictronConnect.
2. Disconnect the charge controller from all power-sources.
3. Wait 3 minutes, and power up again.
4. Reconfigure the charger.

Please do report this to your Victron dealer and ask him to escalate it to Victron; as this error should never happen. Preferably include firmware version and any other specifics (VRM URL, VictronConnect screenshots or similar).