



---

## MX2800ISE

### INVERTER GENERATOR OPERATORS MANUAL



---

Distributed by: Maxwatt Power Products  
Unit 15/16, 1440 New Cleveland Road, Chandler  
Queensland  
Australia

# SAFETY INSTRUCTIONS AND WARNINGS

## ⚠ DANGER

Using a generator indoors **CAN KILL YOU IN MINUTES.**  
Generator exhaust fumes contains carbon monoxide.  
This is a poison you cannot see or smell.

Avoid other generator hazards. **READ MANUAL BEFORE USE.**



NEVER use inside a home or garage,  
EVEN IF doors and windows are open.



Only use **OUTSIDE** and far away  
from windows, doors and vents.

## INTRODUCTION

This Operating Manual has been designed to instruct you on the correct operation of your generator, Your satisfaction with this product and its safe operation is our ultimate concern. Therefore please take the time to read the entire manual, especially the Safety Precautions. They will help you to avoid potential hazards that may exist when working with this product.

**⚠ Read this manual carefully before operating this generator. This manual should stay with this generator if it is sold.**

## TABLE OF CONTENTS

Introduction .....	1
Safety Information .....	3
Generator Safety Warnings .....	4
Know Your Generator .....	7
Generator Preparation .....	12
Starting the Generator .....	16
Shutting Off the Generator .....	18
Maintenance .....	19
Transportation & Storage .....	24
Troubleshooting Guide .....	25
Warranty Information .....	26

## KEY SPECIFICATIONS

Model NO.	MX2800ISE
Starting Wattage	2800W
Running Wattage	2500W
Phase	Single
Frequency	50Hz
Voltage	AC 240V
Amperage	10.42A
Engine Type	4-stroke, OHV, single cylinder with forced air cooling system
Engine Displacement	149CC
Fuel Tank Capacity	7L
Oil Capacity	0.6L

# SAFETY INFORMATION

 **WARNING:** Before operating the generator, make sure to read all safety warnings and all instructions. Failure to follow the warnings and instructions may result in electric shock, fire or serious injury.

## SAFETY INTRODUCTION

Safety is a combination of common sense, staying alert, and knowing how your tool works. This manual contains important information regarding the generator's potential safety concerns, as well as preparation, operation, and maintenance instructions. Before operating this generator, be sure to read and observe all warnings and instructions both on the generator labels and in this instruction manual. Failure to follow all instructions listed below may result in personal injury.

**NOTE:** The following safety information is not meant to cover all possible conditions and situations that may occur. We reserves the right to change this product and specifications at any time without prior notice.

**SAVE THESE INSTRUCTIONS - Please keep this manual available to all users during the entire life of the tool. Review it frequently to maximize safety for both yourself and others.**

## SAFETY SYMBOLS

The purpose of following safety symbols is to attract your attention to possible dangers. The safety symbols, and their explanations, deserve your careful attention and understanding. The safety warnings do not by themselves eliminate any danger. The instructions or warnings they give are not substitutes for proper accident prevention measures.

 **DANGER:** indicates a hazard, which, if not avoided, will result in death or serious injury.

 **WARNING:** indicates a hazard, which, if not avoided, could result in death or serious injury.

 **CAUTION:** indicates a hazard, which, if not avoided, might result in minor or moderate injury.

**CAUTION:** when used without the alert symbol, indicates a situation that could result in damage to the machine.



## GENERATOR SAFETY WARNINGS

### **DANGER: CARBON MONOXIDE**

Using a generator indoors **CAN KILL YOU IN MINUTES**. Generator exhaust fumes contains carbon monoxide (CO). This is a poison gas you cannot see or smell. If you can smell the generator exhaust, you are breathing CO. But even if you cannot smell the exhaust fumes, you could be breathing CO.



NEVER use a generator inside homes, garages, crawl spaces, or other partially enclosed areas. Deadly levels of carbon monoxide can build up in these areas. Using a fan or opening windows and doors does NOT supply enough fresh air. ONLY use a generator OUTSIDE and far away from windows, doors, and vents. These openings can pull in generator exhaust fumes.

Even if you use a generator correctly, CO may leak into the home. ALWAYS use a battery-powered or battery-backup CO alarm in the home. If you start to feel sick, dizzy, or weak after the generator has been running, move to fresh air RIGHT AWAY. See a doctor. You may have carbon monoxide poisoning.

 **WARNING: RISK OF EXPLOSION. HIGHLY FLAMMABLE:** This generator may emit highly flammable and explosive petrol vapors, which can cause severe burns or even death, if ignited. A nearby open flame can lead to explosion even if not directly in contact with petrol.

- Do not operate near open flame, heat, or any other ignition source. Do not smoke near generator.
- Always operate on a firm, level surface.
- Always turn generator off before refueling. Allow generator to cool for at least 2 minutes before removing fuel cap. Loosen cap slowly to relieve pressure in tank.
- Do not overfill fuel tank. petrol may expand during operation. Do not fill to the top of the tank. Allow for expansion. Always check for spilled fuel before operating.
- If fuel spills, move the generator at least 9M away from the spill and wipe clean any spilled fuel before starting the engine.
- Empty fuel tank before storing or transporting the generator.

 **WARNING:** If this generator is used as a supply for a BUILDING'S WIRING SYSTEM, the generator MUST be installed by a qualified electrician and connected to a transfer switch as a separately derived system in accordance with all applicable laws and electrical codes and the National Electrical Code. The generator shall be connected to a transfer switch that switches all conductors excluding the equipment grounding conductor. The frame of the generator shall be connected to an approved grounding electrode.

## GENERATOR SAFETY WARNINGS

 **WARNING:** Do not let comfort or familiarity with the product replace strict adherence to product safety rules. Failure to follow the safety instructions may result in serious personal injury.

### OPERATING ENVIRONMENT

1. Using a generator indoors can kill you in minutes. Only use a generator OUTSIDE and far away from windows, doors and vents.
2. Do not smoke near the generator.
3. Do not operate near open flame, heat, or flammable materials. This generator may emit highly flammable and explosive petrol vapors, which can cause severe burns or even death if ignited. A nearby open flame can lead to an explosion even if it isn't directly in contact with petrol.
4. Do not expose the generator to rainy or wet conditions; doing so significantly increases the risk of electrical shock. Never handle the generator, electronic devices, or any cord while standing in water, while bare-foot, or when hands or feet are wet.
5. Always operate the generator on a dry, firm, level surface.
6. The generator should have at least 1.5M of clearance from buildings or other equipment during operation.
7. Do not allow children or non-qualified persons to operate the generator.

### GENERATOR PREPARATION

1. Always ground the generator before using it to maximize safety (see "GROUND THE GENERATOR" section.)
2. Do not overfill fuel tank, as petrol may expand during operation. Do not fill to the very top of the tank. Leave room for expansion. Always check for spilled fuel before operating.
3. If any part of the generator, electrical device or power cord is broken, damaged, or defective, make sure it is repaired or replaced before operation. Service should only be performed by a qualified technician. Do not use receptacles or cords that show signs of damage, such as broken or cracked insulation.
4. Use a ground fault circuit interrupter (GFCI) in highly conductive areas such as metal decking or steel work.
5. Extension cords with in-line GFCIs are recommended for these operations to maximize safety.
6. If connecting the generator to a building's electrical system for standby power, you MUST consult a qualified electrician and install a transfer switch. Such connections must comply with local electrical laws and codes. Failure to comply can create a back-feed, which may result in serious injury or death to utility workers.
7. Never modify the generator in any way. Modifying or using the machine for any other purpose for which it is not designed may result in serious injuries, machine damage and voiding of the warranty.

# GENERATOR SAFETY WARNINGS

---

## GENERATOR OPERATION

1. Only use the generator for its intended purposes. Modifying or using the generator for operations for which it was not designed may cause hazards and personal injury.
2. Do not touch bare wires or receptacles (outlets).
3. Do not exceed the wattage capacity of the generator by plugging in more electrical devices than the unit can handle. This could damage the generator and/or connected electrical devices. Check the operating voltage and frequency requirements of all electrical devices prior to plugging them into the generator.
4. Allow generator to run for several minutes before connecting electrical devices. Do not start or stop engine with electrical devices plugged in to the receptacles. Failure to do so could damage the generator and / or connected electrical devices.
5. Do not turn ON electrical devices until after they are connected to the generator.
6. Generators vibrate in normal use. During and after the use of the generator, inspect both the generator as well as extension and power supply cords for damage resulting from vibration.
7. Do not touch HOT PARTS. This generator produces heat when running. Temperatures near exhaust can exceed 65°C. Allow generator to cool down after use before touching engine or areas of the generator that become hot during use.
8. Turn off all connected electrical devices before stopping the generator.
9. Always turn generator off before refueling. Allow generator to cool for at least 2 minutes before removing fuel cap. Loosen cap slowly to relieve pressure in tank.
10. Turn the engine switch to "OFF" position when the engine is not running.
11. Empty fuel tank before storing or transporting the generator. Do not store generator or petrol near furnaces, water heaters, or any other appliances that produce heat or have automatic ignitions. Store the generator and fuel away from sparks, open flames, pilot lights, heat and other sources of ignition.
12. Always wash hands after handling generator.

**CAUTION:** Misuse of this generator can damage it or shorten its lifespan.

### **TO MAXIMIZE THE LIFESPAN OF YOUR GENERATOR:**

We recommend running your generator at least once a month for 20 to 30 minutes. Start the generator according to the instructions and plug a small load in to make sure the outlet is producing electricity.

# KNOW YOUR GENERATOR

---

## GENERATOR

---



Muffler/Spark arrestor



# KNOW YOUR GENERATOR

## CONTROL PANEL

### COMPONENTS

#### CONTROL PANEL COMPONENTS

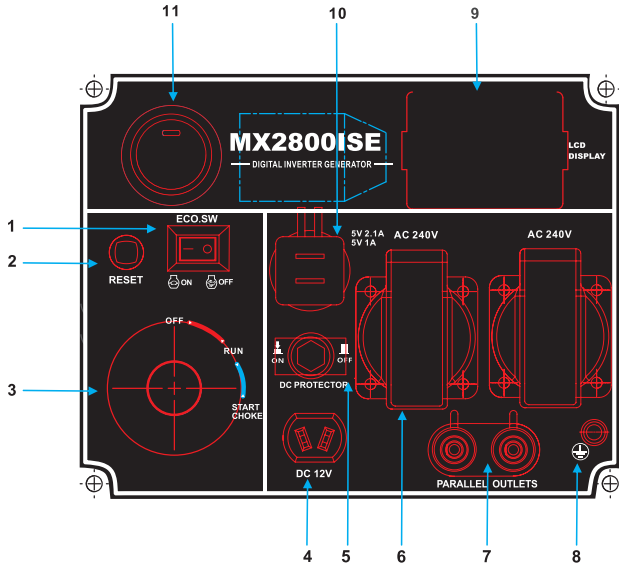

**1. Eco Mode:** Eco mode minimizes fuel consumption and noise by adjusting the engine RPM to the minimum required for the current load.

**2. Overload Reset:** The generator inverter will automatically switch OFF all AC output to protect the generator if overloaded or if there is a short circuit in a connected appliance.

**3. Combined Switch:** Used to turn fuel valve to the Run, Choke, or OFF position.

**4. DC 12V**

**5. DC Protector**

**6. AC 240V**

**7. Parallel Operation Outlets:** A compatible Inverter Generator can be connected for additional power output.

**8. Ground Terminal:** The ground terminal is used to externally ground the generator.

**9. Low Oil LED:** Indicates low oil level. When the oil level in the crankcase falls below the safe operating limit, the low oil level indicator will illuminate and the generator will automatically shut off the engine.

**Overload LED:** Indicates that the generator is overloaded.

**Output Ready LED:** Illuminates when the generator is operating normally. Indicates the generator is producing electrical power at the receptacles.

Remaining time, Cumulative time, Voltage, Frequency

**10. USB Ports:** Two-port 5V/2.1A USB outlet. Accepts Type A USB plugs.

**11. Engine Switch**

## KNOW YOUR GENERATOR

### ECO.SW

This generator is equipped with an LOW IDLE Switch. Engaging this switch allows the system to regulate the engine speed and automatically adjust its fuel consumption to match the required load. When the electrical load changes, the generator engine will automatically speed up and slow down as needed. This reduces fuel consumption and noise levels, while extending runtime and engine's lifespan.

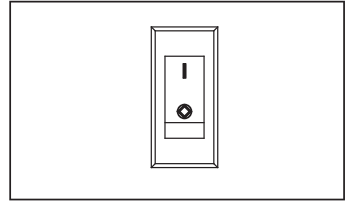

Keep this switch engaged **ONLY** when the power load requirement is **LESS THAN 75%** of the rated watts. Do not engage the switch when the total load is more than 75% of the rated watts. The generator engine must run at full speed to supply power for anything over 75% of the rated watts.

### DC PROTECTOR

The circuit breakers protect the individual AC and DC circuits. The AC circuit breaker will activate when the AC outlets exceed. The DC circuit breaker will activate when the DC 12V and USB outlets exceed. When the circuit breaker activates, turn off and disconnect the device from its respective outlet, and press the circuit breaker to reset.

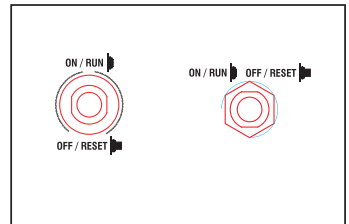

## CONNECTING ELECTRICAL DEVICES

**CAUTION:** Before connecting devices, become familiar with the markings on the control panel before connecting electrical devices.

### Follow the steps below to properly connect your device(s) to the generator:

1. Before connecting electrical devices, allow the generator to run for a few minutes to stabilize the speed and voltage output.
2. Select the device with the highest wattage, and make sure it is turned off. Plug the device into the generator and then turn the device on. Allow the engine to stabilize.
3. Repeat step 2 to plug in each additional device. **DO NOT** attempt to plug in or start multiple devices at the same time.

# KNOW YOUR GENERATOR

## GENERATOR CAPACITY

Make sure the generator can supply enough running (rated) and starting (max.) watts for the items you will power at the same time. Follow these simple steps.

1. Select the items you will power at the same time.
2. Total the running (rated) watts of these items. This is the amount of power the generator must produce to keep the items running.
3. Estimate how many starting (max.) watts you will need. Starting wattage is the short burst of power needed to start electric motor-driven tools or appliances such as a circular saw or refrigerator. Because not all motors start at the same time, total starting (max.) watts can be estimated by adding only the item(s) with the highest additional starting (max.) to the total rated watts.

### Example:

Tool or Appliance	Running Watts*	Additional Starting Watts*
Refrigerator	700	1350
Portable Fan	40	120
Laptop	250	250
46 in. Flat Panel Television	190	190
Light (75 Watts)	75	75

1255 Total Running Watts	1350 Highest Starting Watts
Total Running Watts	1255
Highest Starting Watts	+ 1350
Total Starting Watts Needed	2605

To prolong the life of the generator and attached devices, it is important to take care when adding electrical loads to the generator. There should be nothing connected to the generator outlets before starting its engine. The correct and safe way to manage generator power is to sequentially add loads as follows:

1. With nothing connected to the generator, start the engine as described later in this manual.
2. Plug in and turn on the first load, preferably the largest load you have.
3. Permit the generator output to stabilize (engine runs smoothly and attached device operates properly).
4. Plug in and turn on the next load.
5. Again, permit the generator to stabilize.
6. Repeat steps 4 and 5 for each additional load.

Never add more loads than the generator capacity. Take special care to consider surge loads in generator capacity as previously described.

### NOTICE:

Do not overload the generator's capacity. Exceeding the generator's wattage/ampere capacity may damage the generator and/or electrical devices connected to it.

## **KNOW YOUR GENERATOR**

---

The chart below serves as a reference for the estimated wattage requirements of common electrical devices. However, do not solely rely on this chart - all electronics and appliances are built differently. Always check the wattage listed on the electrical device before consulting this chart.

<b>Tool or Appliance</b>	<b>Rated (Running) Watts</b>	<b>Surge (Starting) Watts</b>
Hot plate	2500	0
Electric stove (each element)	1500-2800	0
Saw - circular	1500	1500
Window air conditioner	1200	1800
Saw - miter	1200	1200
Microwave	1000	0
Well water pump	1000	1000
Sump pump	800	1200
Refrigerator freezer	800	1200
Furnace blower	800	1300
Computer	800	0
Electric drill	600	900
Television	500	0
Stereo	400	0
Box fan	300	600
Security system	180	0
Common light bulb	75	0



# GENERATOR PREPARATION

The following section describes the necessary steps to prepare the generator for use. Failure to perform these steps properly can damage the generator or shorten its life.

## STEP 1 - ADD/CHECK OIL

The generator is shipped without oil. User must add the proper amount of oil before operating the generator for the first time. The oil capacity of the engine crankcase is 0.6L.

### To add oil, follow these steps:

1. Place the generator on a level surface. Make sure the engine is OFF before adding or checking oil.

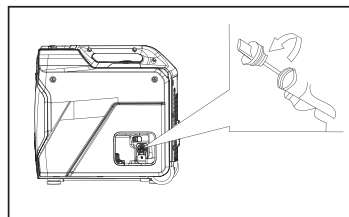

**CAUTION:** Keep the generator level! Tilting the generator to assist in filling will cause oil to flow into the wrong areas of the engine and cause damage.

2. Unscrew the oil access cover knob, and remove the cover from the side panel. Unscrew the oil dipstick from the engine.

3. Using an oil funnel or appropriate dispenser, slowly add oil into the oil fill, being careful not to overfill the unit. Fill the crankcase to the upper fill line so you can visually see the oil coming halfway up the oil fill threads.

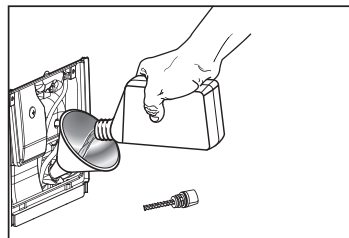

4. Reinstall the oil dipstick and firmly tighten it. Wipe clean any spilled oil.

5. Reinstall the oil access cover. Turn the oil access cover knob to the locked position to secure the cover in place.

**NOTE:** Used engine oil should be disposed of at an approved disposal site. See local retailer for more information.

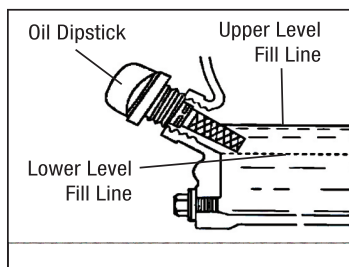
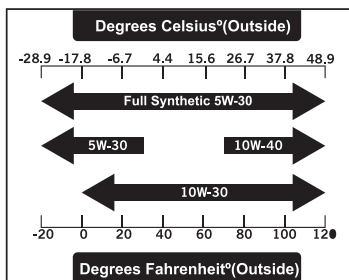

For subsequent operation, the oil level should be checked before each use, or after every 8 hours of operation. The generator is equipped with a low-oil sensor and will NOT start without a sufficient amount of oil.

## GENERATOR PREPARATION

### To check oil level (before every subsequent start):

Place the generator on a level surface. Make sure the engine is OFF before adding or checking oil.

1. Open the oil access cover. Remove and wipe the dipstick with a clean rag.
2. Insert the dipstick into the oil fill without screwing it in. Remove the dipstick to check the oil mark.

If the oil mark covers less than one half of the dipstick, slowly add oil until the oil mark reaches to the top of the dipstick (or when you can see the oil coming halfway up the oil fill threads).

3. Wipe clean any oil leaks and firmly tighten the dipstick. Reinstall the oil access cover.

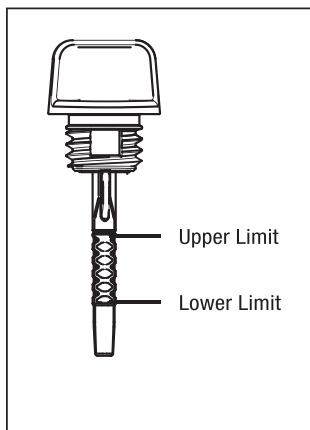

## STEP 2 - ADD/CHECK FUEL

**PETROL WARNING:** Keep generator away from open flame. This generator may emit highly flammable and explosive petrol vapors, which can cause severe burns or even death if ignited. A nearby open flame can lead to explosion even if not directly in contact with petrol.

- Do not operate near open flame, heat, or any other ignition source.
- Do not smoke near the generator.
- Always operate on a firm, level surface.
- Always turn generator off before refueling. Allow generator to cool for at least 2 minutes before removing the fuel cap. Loosen cap slowly to relieve pressure in tank.
- Do not overfill fuel tank. Fuel may expand during operation. Do not fill to the top of the tank. Allow for expansion.
- Always check for spilled fuel before operating. Clean up any spilled fuel before starting.
- Empty fuel tank before storing or transporting the generator to prevent spilling.

Use **ONLY** fresh (within 30 days from purchase), lead-free petrol with a **minimum of 87 octane rating**. The generator performs best with ethanol-free petrol. **DO NOT** use petrol with over 10% ethanol. The capacity of the fuel tank is **7L** **DO NOT** mix oil with petrol.

### NOTICE:

- Never use an oil/petrol mixture.
- Never use old petrol.
- Keep petrol away from sparks, open flames, pilot lights, heat and other sources of ignition.
- Avoid getting dirt or water into the fuel tank.
- Petrol can age in the tank and make starting difficult. Never store generator for more than 2 months with fuel in the tank.

# GENERATOR PREPARATION

## To add petrol, follow these steps:

1. Make sure the generator is shut OFF and on a level surface. Unscrew the fuel cap and set it aside. The fuel cap may be tight and hard to unscrew.
2. Slowly add unleaded petrol to the fuel tank. Be careful not to overfill.

**NOTE:** Do not fill the fuel tank to the very top. If you do, petrol will expand and spill during use, even with the fuel cap in place.

3. Reinstall fuel cap and wipe clean any spilled petrol with a dry cloth.

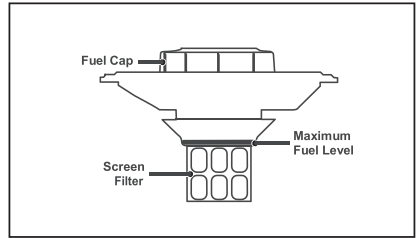

## To check fuel level:

During operation, the fuel level will be displayed on the DATA CENTER of the panel, or check the fuel gauge. If the fuel level is low, refill the fuel tank before starting your generator for the next time.

## STEP 3 - CONNECT THE BATTERY

**⚠ WARNING:** BATTERY GIVES OFF EXPLOSIVE HYDROGEN GAS.

- Keep battery away from sparks, cigarettes, or other sources of flame.
- Do not connect or disconnect battery while generator is running.
- Service or use battery only in well ventilated areas.

**⚠ WARNING:** Battery contains sulfuric acid. Battery acid is poisonous. Tilting the generator with the battery installed can cause battery acid to spill.

- Wear protective clothing and eye wear when servicing battery.
- Keep out of reach of children.
- If battery acid gets on your skin, wash with water immediately.
- If battery acid gets in your eyes, flush with water for at least 15 minutes and call a doctor immediately.

If battery acid is swallowed, call a doctor immediately. Drink a large amount of water or milk. Then drink milk of magnesia or vegetable oil.

The generator is shipped with the battery's negative (-) terminal disconnected to maximize safety. To start the generator using electric start, the battery must be connected.

## To connect the battery:

1. Turn the battery cover knob to the unlocked position, and remove the access cover from the back panel.
2. Loosen the rubber belts and pull out the battery.

## GENERATOR PREPARATION

3. Remove the cover from the battery's negative (-) terminal and connect the black cable to the battery's negative (-) terminal.

The generator's positive pole has already been connected. Double check to confirm that the connection is secure.

4. Return the battery into position and use the rubber belts to fasten the battery.

5. Reinstall and secure the battery access cover.

**NOTICE:** If you do not plan to use the generator for a long period of time, we recommend to DISCONNECT the negative battery cable from the battery to protect the battery from losing charge. After disconnecting the cable, cover the free end with an insulator such as electrical tape. You may also choose to use a trickle charger (not included) to maintain battery charge.

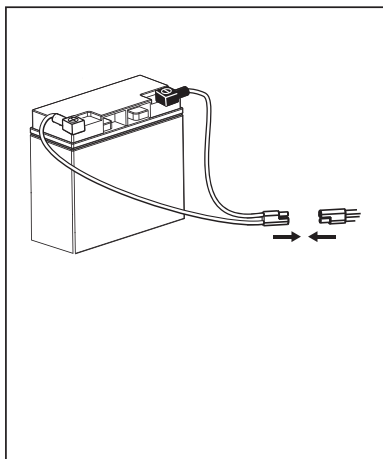

### STEP 4 - GROUND THE GENERATOR

To reduce the risk of electric shock and to maximize safety, the generator should be properly grounded.

Ground the generator by tightening the grounding nut on the front control panel against a grounding wire. A generally acceptable grounding wire is a **4mm<sup>2</sup> (Australian stranded copper wire)**.

This grounding wire should be connected at the other end to a copper, brass, or steel grounding rod that is driven into the earth. Wire and grounding rods are not included with the generator.

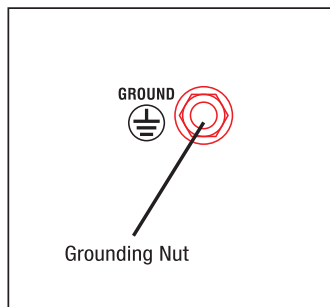

**NOTE:** Grounding codes can vary by location. Contact a local electrician to check the area codes.



**WARNING:** Failure to properly ground the generator increases your risk of electric shock.

### HIGH ALTITUDE OPERATION ABOVE 915 METERS

The fuel system on this generator may be affected by operation at high altitudes. At elevations above 2438 meters, the engine may experience a decrease in performance, even with the proper altitude kit. Operating this generator may increase the engine's emissions and decrease both fuel economy and performance. Please contact your authorized service center for important information regarding these modifications.

## STARTING THE GENERATOR

Before starting the generator, make sure you have read and performed the steps in the “Generator Preparation” section of this manual. If you are unsure about how to perform any of the steps in this manual Please contact your authorized service center

### **DANGER: CARBON MONOXIDE**

Using a generator indoors **CAN KILL YOU IN MINUTES**. Generator exhaust fumes contains carbon monoxide(CO). This is a poison gas you cannot see or smell. If you can smell the generator exhaust fumes, you are breathing CO. But even if you cannot smell the exhaust fumes, you could be breathing CO.

NEVER use a generator inside homes, garages, crawl spaces, or other partially enclosed areas. Deadly levels of carbon monoxide can build up in these areas. Using a fan or opening windows and doors does NOT supply enough fresh air. ONLY use a generator OUTSIDE and far away from windows, doors, and vents. These openings can pull in generator exhaust.

Even if you use a generator correctly, CO may leak into the home. ALWAYS use a battery-powered or battery-backup CO alarm in the home. If you start to feel sick, dizzy, or weak after the generator has been running, move to fresh air RIGHT AWAY. See a doctor. You may have carbon monoxide poisoning.

**WARNING:** DO NOT operate generator near open flame or flammable materials This generator may emit highly flammable and explosive petrol vapors, which can cause severe burns or even death if ignited. A nearby open flame can lead to explosion even if it isn't directly in contact with petrol. Do not smoke near the generator.

**WARNING:** This generator produces powerful voltage, which can result in electrocution.

**WARNING:** Do not use in rainy or wet conditions. Do not touch bare wires or receptacles (outlets). Do not allow children or non-qualified persons to operate.

**WARNING:** Generator should ONLY be connected to electrical devices, either directly or with an extension cord. NEVER CONNECT TO A BUILDING ELECTRICAL SYSTEM without a qualified electrician and connected to a transfer switch as a separately derived system. Such connections must comply with local electrical laws and codes. Failure to comply can create a back-feed, which may result in serious injury or death to utility workers.

To maximize safety, ALWAYS ground the generator before using it .

Use a ground fault circuit interrupter (GFCI) in highly conductive areas such as metal decking or steel work. GFCIs are available in-line with some extension cords.

**CAUTION:** Disconnect all electrical loads from the generator before attempting to start.

# STARTING YOUR GENERATOR

## Before starting the generator:

1. Verify that the generator is outside on a dry, level surface. Allow at least 1M of clearance on all sides of the generator.
2. To maximize safety, check that the generator is properly grounded (see "GROUND THE GENERATOR").
3. Check there is sufficient level of oil in the crankcase. Add oil if necessary (see "ADD/CHECK OIL").
4. Make sure there is sufficient level of petrol in the fuel tank. Add fuel if necessary (see "ADD/CHECK FUEL").
5. Make sure all electrical devices are unplugged from the generator during ignition. Otherwise it will be difficult for the engine to start.

## To start the generator, perform the following steps:

1. Turn the Fuel Saving switch to "OFF" position.

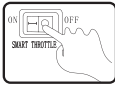

5. Press & hold the "Start Button" for 4 seconds and wait for the generator to start.



2. Turn the Air Knob on the Fuel Tank to the "On" position.

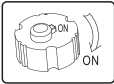

6. To manual start pull the Recoil Starter until resistance is felt. Do not pull the rope of the recoil starter out completely.



3. Open the Fuel Choke.

4. Turn the Combined Switch to "Start" position.

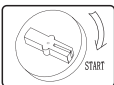

7. After starting the generator allow the engine to warm up and rotate the Combined Switch to the "Run" position.

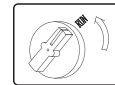

**Note:** The generator can be started from the Run position if warm from operation.

8. After starting the engine successfully, press the fuel-saving switch in the "On" position.

## SHUTTING OFF THE GENERATOR

---

 **CAUTION:** Unplugging running devices can cause damage to the generator. Never stop the engine with electrical devices connected and running.

1. Turn OFF and unplug all connected electrical loads. Never start or stop the generator with electrical devices plugged in or turned on.
2. Let the generator run with no load for several minutes to stabilize internal temperatures of the engine and generator.
3. Turn the engine/fuel switch to the OFF position
4. Allow the engine to cool, then turn the fuel cap vent to the OFF position.

Note: If there is an emergency and the inverter must be stopped quickly, immediately move the fuel switch to the OFF position.

In case you are in a hurry and do not want to wait for the generator to automatically shut down, the manual shutoff feature is available. However, this method will leave stagnant fuel in the carburetor, possibly causing blockages, a shortened lifespan, and other maintenance issues. If this approach is frequently taken, make sure to drain your carburetor before any long storage periods.

**CAUTION:** Allowing petrol to sit in the fuel tank for long periods of time can make it difficult to start the generator in the future. NEVER store the generator for extended periods of time (over 2 months) with fuel in the fuel tank. Refer to “STORING THE GENERATOR”.

# MAINTENANCE

## RECOMMENDED MAINTENANCE SCHEDULE

Proper routine maintenance of the generator will help prolong the life of the machine. Please perform maintenance checks and operations according to the Maintenance Schedule. If there are any questions about the maintenance procedures listed in this manual, Please contact your authorized service center.

**⚠ WARNING:** Never perform maintenance operations while the generator is running. Before maintaining or servicing the generator, turn OFF the generator, disconnect all devices and allow the generator to cool down.

Recommended Maintenance Schedule		Each 8 hours or daily	Every 25 hours	Every 3 months or 50 hours	Every 6 months or 100 hours	Before Storage	As necessary
<b>Engine Oil</b>	Check level	x					
	Replace		x*			x	x
<b>Air Filter</b>	Check			x*			
	Clean			x*			
<b>Spark Plug</b>	Check/clean/regap				x		
	Change					x	x
<b>Fuel Tank</b>	Check level	x					
	Drain					x	x
<b>Carburetor (Auto Shutoff)</b>	Drain					x	x
<b>Carburetor (Manual Shutoff)</b>		x				x	
<b>Spark Arrestor</b>	Check/Clean				x		
<b>Battery</b>	Disconnect					x	

\* Clean/change more often under dusty conditions or operating under heavy load.

**IMPORTANT GENERATOR MAINTENANCE TIPS:**

- Drain your carburetor after each use and before storage to prevent it from clogging.
- Do not store the generator with fuel inside the tank for more than 2 months - the fuel will go bad.
- Run the generator for at least 20 minutes every month to charge the battery and maximize the generator's lifespan.

**NOTE: Failure to properly maintain the generator will void the warranty.**



## MAINTENANCE

### Air Filter Maintenance

1. Remove the maintenance cover plate on the side of the unit.
2. Remove knob and air filter cover plate .
3. Remove the filter element.
4. If the filter element is dirty, wash it with warm soap and clean water and dry it.
5. Apply a layer of engine lubricant on the filter element and squeeze it out.
6. Reinstall the filter element into the air cleaner unit.
7. Reinstall the air filter cover plate .
8. Reinstall the side maintenance cover plate of the unit.

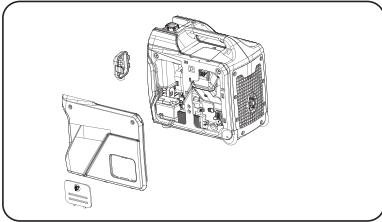

### Battery Replacement

#### **⚠ WARNING**

Burn hazard. The battery contains sulfuric acid (electrolyte) which is highly corrosive and poisonous. Wear protective clothing and eye protection when working near the battery. Keep children away from the battery.

#### **⚠ CAUTION**

Battery posts, terminals contain lead and lead compounds. Wash hands after handling.

1. Unscrew the knob and remove the left maintenance cover plate .
2. Loosen the nuts and remove the battery cover.

3. Replace the battery with a new battery.  
Battery Specification: 12V, sealed lead acid.  
LxWxH:5.9x3.3x4.1 inches (150x85x106mm)
4. Put the battery back in place and fix it with nuts and battery cover plate.
5. Reinstall and fix the left maintenance cover plate.

#### **⚠ NOTICE**

Dispose of the used battery properly according to the guidelines established by your local or state government.

### Spark Plug Maintenance

The spark plug must be properly gapped and free of deposits in order to ensure proper engine operation. To check:

1. Turn knob and remove the maintenance cover.
2. Remove the spark plug cap .
3. Clean any dirt from around base of spark plug.
4. Remove spark plug using provided wrench.
5. Inspect spark plug for damage, and clean with a wire brush before reinstalling. If insulator is cracked or chipped, spark plug should be replaced.
6. Measure plug gap. The correct gap is 0.028-0.031 in. (0.7-0.8 mm). To widen gap, if necessary, carefully bend the ground (top) electrode. To lessen gap, gently tap ground electrode on a hard surface.
7. Seat spark plug in position; thread in by hand to prevent cross-threading.
8. Tighten with wrench to compress washer. If spark plug is new, use 1/2 turn to compress washer appropriate amount. If reusing old spark plug, use 1/8 to 1/4 turn for proper washer compression.

#### **NOTE:**

An improperly tightened spark plug will become very hot and could damage the engine.

9. Reinstall the spark plug cap .

## MAINTENANCE

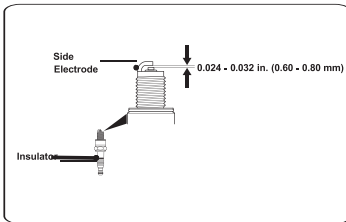

### Valve Clearance

**Important:** Please contact Authorized Service Center for service assistance. Proper valve clearance is essential for prolonging the life of the engine. Check valve clearance per maintenance schedule.

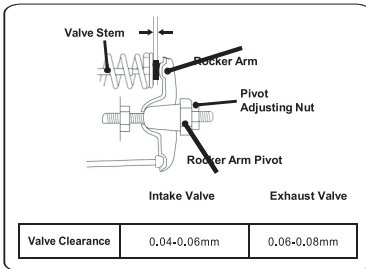

### NOTICE

Checking and adjusting valve clearance must be done when the engine is cold.

### Cleaning the Spark Arrester

1. Allow the engine to cool completely before repairing the spark arrester.
2. Loosen the bolt (A) to remove the flange pressing plate (B) and the spark arrester (C).
3. Carefully remove carbon deposits on the filter screen of spark arrester (C) with a steel wire brush.
4. If the spark arrester (C) is damaged, replace it.
5. Place the spark arrester (C) on the muffler and reinstall it with the bolts removed in step 2.

### NOTE:

This product is equipped with a spark arrester that has been evaluated by the USDA Forest Service; however, product users must comply with Federal, State, and local fire prevention regulations. Check with appropriate authorities. Contact customer service or a qualified service center to purchase a replacement spark arrester.

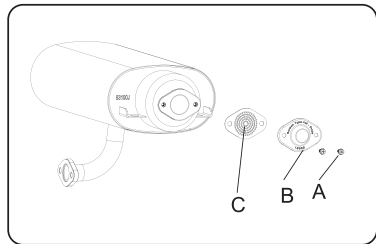

### GENERATOR MAINTENANCE

Make certain that the generator is kept clean and stored properly. Only operate the unit on a flat, level surface in a clean, dry operating environment.

**DO NOT** expose the unit to extreme conditions, excessive dust, dirt, moisture or corrosive vapours.

### NOTE:

**DO NOT** use a garden hose to clean the generator.

Water can enter the generator through the cooling slots and damage the generator windings.

Use a damp cloth to clean exterior surfaces of the generator.

Use a soft bristle brush to remove dirt and oil.

Use an air compressor 25 PSI (172 kPa) to clear dirt and debris from the generator.

Inspect all air vents and cooling slots to ensure that they are clean and unobstructed.

### STORAGE

It is recommended to start and run the generator for 30 minutes, every 30 days. If this is not possible, refer to below short term and long term storage.

## MAINTENANCE

### DRAINING THE FUEL TANK / CARBURETOR

To help prevent gum deposits in the fuel system, drain the fuel from the tank and carburetor before storing.

1. With the help of another person, place the generator on an elevated platform such as a table or desk.

2. Unscrew the maintenance cover knob, and remove the cover from the side panel.

#### To draining fuel tank:

3. Make sure that the fuel switch is turned to "ON".

#### To draining carburetor:

1. Make sure that the fuel switch is turned to "OFF", at this position, the fuel valve is turned OFF so that only the fuel left inside the carburetor will be drained out.

2. The carburetor can be accessed between the engine and the air filter. Locate the transparent tube from the carburetor that extends down through the base plate of the generator.

3. Prepare an approved petrol-storage container and direct the end of the drain tube into the container.

4. Open up the carburetor drain screw with a flat-head screwdriver (not included) and drain out any petrol that has built up inside the carburetor through the drain tube into the approved petrol-storage container.

5. Once the fuel has drained, tighten the drain screw with the screwdriver.

6. **NOTE:** Make sure to drain your carburetor before storing the generator for long periods of time.

7. Reinstall the service panel.

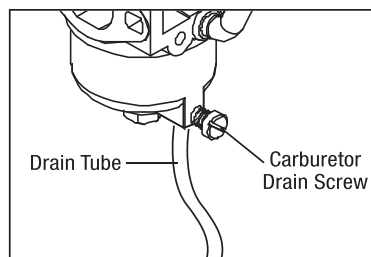
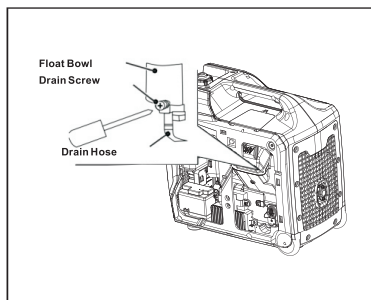

# MAINTENANCE

## DRAINING/CHANGING OIL

### Change the oil according to the Recommended Maintenance Schedule.

Change the oil MORE OFTEN if operating under heavy load or high ambient temperatures. It is also necessary to drain the oil from the crankcase if it has become contaminated with water or dirt. Changing the oil when the engine is warm allows for complete drainage.

#### To change engine oil:

1. With the help of another person, place the generator on an elevated platform such as table or workbench.

**NOTE:** To avoid possible oil spills from the carburetor bowl, drain the carburetor before draining oil.

2. Unscrew the oil access cover knob, and remove the cover from the side panel.

3. Place a suitable container underneath the generator to catch the used oil.

4. Reach under the generator and remove the black rubber seal located below the oil drain plug.

5. Remove the oil fill cap/dipstick.

6. Use a wrench to remove the oil drain plug and allow the oil to drain completely.

7. Reinstall the oil drain plug after the oil has drained.

8. Reinstall the black rubber seal.

**NOTE:** Never dispose of used engine oil in the trash or down a drain. Please call a local recycling center or auto garage to arrange proper oil disposal.

9. With the generator in a level position and refill with engine oil following the instructions in the Checking/Adding engine oil section previously in this manual.

10. Reinstall the oil dipstick and tighten it securely. Wipe clean any oil spillage and reinstall the oil access cover.

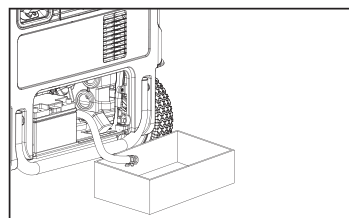
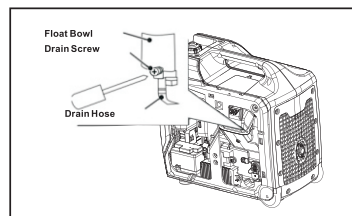

## TRANSPORTATION & STORAGE

### TRANSPORTING THE GENERATOR

To prevent fuel spillage when transporting, be sure to perform the following:

1. Tighten the fuel cap and turn the vacuum relief valve to "OFF".
2. Set the engine switch to "OFF".
3. Drain the fuel tank if possible.
4. Keep the generator upright. Never place the generator on its side or upside down - doing so will make it difficult to start.

 **WARNING:** Avoid direct sunlight inside a vehicle. If the generator is left in an enclosed vehicle for many hours, the high temperature could cause the fuel to vaporize and result in a possible explosion.

### STORING THE GENERATOR

Shut off the generator and allow the unit to cool to room temperature before storing it. NEVER place any type of storage cover on the generator while it is still hot. Do not obstruct any ventilation openings.

Follow the procedures below for properly storing your generator. We highly recommend running your generator once a month for 20 to 30 minutes. Plug in a small load in to ensure there is proper power output.

#### For Short Periods (30 to 60 Days):

- Drain the carburetor.
- Disconnect the negative lead from the battery.
- **Add fuel stabilizer:**

Follow the suggested portions and instructions of your preferred stabilizer. Run the engine for 15 to 20 minutes, allowing the fuel stabilizer to mix with the petrol and circulate through the carburetor, and then top off with fuel. Filling the fuel tank full reduces the amount of air in the tank and helps fight deterioration of fuel.

#### For Extended Periods (Over 60 Days):

- Disconnect the negative lead from the battery.
- Drain the fuel tank and carburetor (see "DRAINING THE FUEL TANK"). NEVER store generator with fuel in the tank for more than two months.
- Change the engine oil (see "CHANGING OIL").

 **WARNING:** Store the generator upright in a cool and dry location, away from sources of heat, open flames, sparks or pilot lights.

### PRODUCT DISPOSAL

Do not dispose of used generator or parts with your household waste. This product contains electrical or electronic components that should be recycled. Please take this product to your local recycling facility for responsible disposal to minimize its environmental impact.

Do not dispose of used oil or fuel in the trash or down a drain. Please contact your local recycling center or auto garage to arrange proper oil/fuel disposal.

## TROUBLESHOOTING GUIDE

---

### ENGINE WILL NOT START

Possible Cause	Solution
Battery not charged.	Charge battery.
Engine switch is in the OFF position.	Turn engine switch to the ON position.
No fuel.	Fill fuel tank.
Stale petrol or water in petrol.	Drain entire system and refill with fresh fuel.
Engine oil level is low.	Engine is equipped with Low Oil Shutoff. If engine oil level is low, it must be filled before unit will start. Check engine oil level and fill, if necessary.
Fuel-switch is in OFF position.	Turn fuel-switch to the ON position.
Spark plug faulty, fouled, or improperly gapped.	Replace spark plug.
Engine stored without treating or draining petrol, or refueled with bad petrol.	Drain fuel. Refuel with fresh petrol.
Dirty fuel filter.	Replace fuel filter or contact a qualified service center.

### ENGINE LACKS POWER.

Possible Cause	Solution
Dirty air filter.	Check air filter element. Clean or replace as needed.
Engine stored without treating or draining petrol, or refueled with bad petrol.	Drain fuel. Refuel with fresh petrol. If problem continues, contact a qualified service center.

### AC RECEPTACLE DOES NOT WORK.

Possible Cause	Solution
OUTPUT indicator is OFF, and OVERLOAD indicator is ON.	Check AC load. Stop and restart the engine. Check the cooling air inlet. Stop and restart the engine.
AC Circuit protector(s) tripped.	Check AC load and reset AC circuit protector(s)
GFCI system activated.	Reset the GFCI.
Item plugged in is defective.	Try a different item.

If problem persists after trying the above solutions, contact your nearest authorized service center for assistance.

# WARRANTY INFORMATION

---

## WARRANTY CONDITIONS

Thank you for purchasing a quality Maxwatt Power product.

Subject to the exclusions set out below.

Maxwatt Power Products PTY Ltd (the "Company") warrants that that this product will be free from defects in materials or workmanship for (2) years or (500) operating hours, whichever occurs first, from the date of original sale (hereinafter the "Warranty Period") in normal domestic applications such as personal, residential household or recreational use from the date of purchase.

A Warranty Period of (2) years or three hundred (300) operating hours, whichever occurs first, shall apply in commercial applications such as income producing, rental or other business-related use. Goods sold to a Consumer with an Australian Business Number shall be deemed as being used in a commercial application.

The Warranty Period is continuous from the date of original sale and does not restart upon the repair or replacement of the Goods or any part thereof.

The benefits conferred by this warranty are in addition to all rights and remedies which you may be entitled to under the Australian Consumer Law and any other statutory rights you may have under other applicable laws. This warranty does not exclude, restrict, or modify any such rights or remedies.

## LIMITED WARRANTY

"This is a "walk in" warranty policy and is limited to the range of generators specified herein". We recommend that you take the generator to the nearest service agent for assistance. Please visit [www.maxwatt.com.au](http://www.maxwatt.com.au) for more information. Upon return – transportation charges shall be borne and prepaid by the Consumer – to the Company's or its nominated dealer's premises within the Warranty Period, the Company shall repair or replace, at its option, any Goods which it determines to contain defective material or workmanship and shall return said Goods to the Consumer free-on-board at the Company's or agent's premises. The repair or replacement work will be scheduled and performed according to the Company's normal workflow and availability of replacement parts.

The Company shall not be obligated, however, to repair or replace Goods which have been repaired by others; abused; improperly installed, operated, maintained, repaired, transported, or stored; not serviced to schedule using genuine spare parts; altered or otherwise misused or damaged in any way. This warranty does not apply where a defect or other issue with the product is caused by normal wear and tear, misuse, or abuse of this product.

## WHAT THE APPOINTED SERVICE AGENT WILL REPAIR OR REPLACE UNDER WARRANTY:

"The appointed Service Agent will repair or replace, at its sole discretion, any part that is proven to be defective in material or workmanship under normal use during the applicable warranty time period. Warranty repairs will be made without any charge for parts and labour.

All parts replaced will be considered as part of the original product and the warranty on such parts will expire coincident with the original product warranty.

# WARRANTY INFORMATION

---

## EXCLUSIONS TO THIS LIMITED WARRANTY INCLUDE:

Neglect in the periodic maintenance as specified in the owner's manual.

Improper repairs or maintenance including any repairs and or maintenance carried out by a non-accredited service agent.

Operating methods other than those indicated in the owner's manual.

The use of non-genuine parts and or accessories other than those supplied by an accredited service agent.

Normal wear and tear including but not limited to the fading of painted or plated surfaces.

Consumable parts including but not limited to keys, spark plugs, fuel and oil filters, recoil starter ropes, wheels, lubricants, oil, grease, and fuel.

Cleaning adjustments and normal periodic maintenance work including but not limited to cleaning the battery, carburetor, engine oil, fuel tank and injectors.

Overloading resulting in the damage of the circuit breaker, stator and rotor.

Charging and proper maintenance of the battery.

Correct preparation when using the generator for the first time as set out in the owner's manual.

Fire damage because of but not limited to overloading, incorrect installation, incorrect re-fueling and any other causes as set out in the owner's manual.

Damage to any electronic and or electrical appliances connected to the generator.

## BELOW IS A TABLE OF PARTS THAT ARE LIMITED BY THIS WARRANTY

### BELOW TABLE OF PARTS THAT ARE LIMITED BY THIS WARRANTY:

PARTS	OUT OF BOX FAILURE (LESS THAN 20 RUNNING HOUR)
STATOR	x
ROTOR	x
CIRCUIT BREAKER	x
IGNITION COIL	x
SPARK PLUG	x
BATTERY	x

### \*NOTE:

OUT OF BOX FAILURE REFERS TO A MACHINE THAT HAS RUN FOR < 20 MINUTES.



# WARRANTY INFORMATION

---

## **DISCLAIMER OF IMPLIED WARRANTIES**

Maxwatt Power Products disclaims any responsibility for the loss of time or use of the product, transportation, commercial loss or any other incidental or consequential loss or damage. Any implied warranties are limited to the duration of this written limited warranty policy and procedures manual.

## **Proof of Purchase**

It is recommended that you keep a copy of the original tax invoice for your records.

## **Warrantor**

Name: Maxwatt Power Products Pty Ltd

Address: Unit 15/16 1440 New Cleveland Road Chandler 4155





Phone: 0737325363

Email: [customercare@maxwatt.com.au](mailto:customercare@maxwatt.com.au)



























Web: [www.maxwatt.com.au](http://www.maxwatt.com.au)

# WARRANTY INFORMATION

**Please Note the Following Terms & Conditions.**

- ➔  — Customer is required to return the generator to the store.
- ➔  — The generator will be repaired at no charge to the customer should the fault be deemed a manufacturer defect only.
- ➔  — The approximate lead time for repairs is **14 - 21 working days** from the time the generator is received at the Maxwatt Service Center.
- ➔  — A copy of the proof of purchase is required when returning the generator for repairs. The warranty is null and void without a copy of proof of purchase.

**NOTE: THE FOLLOWING IS EXCLUDED FROM THE MANUFACTURER WARRANTY POLICY.**

-   — Neglect in the periodic maintenance as specified in the owners / operator's manual.
  -   — Operating methods other than those indicated in the owner / operator's manual.
  -   — Overloading resulting in the damage to the Inverter / Circuit Breaker / Alternator.
  -   — Improper repairs or maintenance carried out.
  -   — Normal “wear & tear” due to day-to-day use & operation.
  -   — The in-correct installation resulting in the damage to the Inverter / Alternator / Control Panel and remote.
- 
- |  |   |   |   |   |   |   |   |   |
|--|---|---|---|---|---|---|---|---|
|  |  |  |  |  |  |  |  |  |
|  |  |  |  |  |  |   |   |   |

# WARRANTY INFORMATION

---



## CHECK LIST PRIOR TO SENDING THE GENERATOR IN FOR ASSESSMENT / REPAIR.



— Ensure that the battery is charged.



— Ensure that there is the correct amount of oil and that it does not need to be replaced.



— Ensure that there is sufficient fuel.



— Ensure that the spark plug does not need to be cleaned or replaced.



— Ensure that the generator **has been serviced** if it has run for more than 50 hours. Check the owners / operator's manual for information.



