

# MTS-TM100

Flat Roof Tilt Mount

Version 1.4



## Important Safety Instructions

Please save these instructions.

This manual contains important safety, installation, and operating instructions for the charge controller. The following symbols are used throughout the manual to indicate potentially dangerous conditions or important safety information.

**WARNING**

Indicates a potentially dangerous condition. Use extreme caution when performing this task

**CAUTION**

Indicates a critical procedure for safe and proper operation of the controller

**NOTE**

Indicates a procedure or function that is important to the safe and proper operation of the controller.

### General Safety Information

- Read all the instructions and cautions in the manual before beginning the installation.
- Chance to strip nuts and bolts exists.
- Do NOT substitute parts from other manufacture ring sources, doing so may void the warranty and/or result in an unstable system
- This system is **NOT** possess any compliance with residential structural codes and should not be used in place of a system that is, if so required by local regulations

### Installer Responsibilities

- Installation compliance with any applicable codes which are in force at the installation site.
- Installation compliance and compatibility with all system components and the environment including but not limited to roofing, system components, etc.
- Verification that all project information is accurate

**WARNING**

This equipment should be installed, adjusted, and serviced by qualified electrical maintenance personnel familiar with the construction and operation of the equipment and the hazards involved. Failure to observe this precaution may result in bodily injury. Protective gloves and safety glasses should be worn during installation.

# Table of Contents

General Information .....	03
Identification of Components .....	04
Installation .....	06
Fasten L-Joint to Back of Solar Panel .....	06
Attach L-Joint to L-Bracket Foot .....	08
Attach Extension Bracket to L-Joint .....	09
Attach L-Bracket Foot to Extension Bracket .....	10
Mounting Recommendations .....	11
Dimensions .....	12
Compatibility .....	14

## General Information

The Renogy Tilt Mount will support various mounting applications, especially in off-grid. It is suitable for most Renogy panels and can be mounted on any flat surface. This mount is designed to allow some adjustment of the panel's angle for optimum performance. The angle adjustability is dependent on the panel size, with larger panel sizes decreasing angle adjustability.

### Key Features

- 5052-H32 aluminum construction
- Stainless steel fasteners
- High-tensile strength
- Corrosion Free
- Attractive brushed aluminum finish
- Precision hole positioning and alignment
- Easy, rapid assembly

### Angle Adjustability

NOTE

The angles for the Renogy Tilt Mount are based off a landscape panel installation. As the solar panel size increases, the angle freedom decreases.

NOTE

The following angles are a general framework based on extension bracket length. The minimum angle maximizes the extension bracket length while the maximum angle minimizes the extension bracket length.

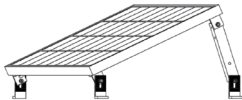

Maximum Angle°

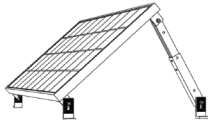







Minimum Angle°

Panel Models	Minimum Angle°	Maximum Angle°	Degree Freedom
50W Mono	38	65	20
50W Poly	39	65	20
100W Mono	89	65	20
100W Poly	51	70	15
100W Eclipse	36	64	28
150W Mono	64	77	13
280W Mono	64	76	12
250W Poly			
270W Poly			
320W Poly			

## Identification of Components

Part	Part Name	Quantity
Extension Bracket (A)		2
L-Bracket Foot (B)		4
L-Joint (C)		4

Part	Part Name	Quantity
M8 Cap Bolt-55mm (D)		4
M8 Cap Bolt-25mm (E)		6
M8 Nut (F)		10
M8 Spring Washer (G)		10
M8 Flat Washer (H)		20
4mm Hex Key (I)		1
Set Screw (J)		4

# Installation

**WARNING**

The equipment should be installed, adjusted, and serviced by a qualified electrical maintenance personnel familiar with the construction and operation of the equipment and hazards involved. Failure to observe this precaution may result in bodily injury. Protective gloves and safety glasses should be worn during installation.

**CAUTION**

The stripping of the threads on the nuts and bolts is possible.

## Recommended Tools (Not provided)

- Socket wrench
- Torque extension
- High-tensile strength
- Box-Leveler
- Tape Measure
- 18mm wrench or socket for larger hex nut
- 13mm wrench or socket for smaller hex nut

The above tools and equipment are highly recommended to have available to assist with installation but are in no way a comprehensive list of tools that can ease installation. Installers feel free to substitute comparable equipment where appropriate.

## Fasten L-Joint to Back of Solar Panel

**NOTE**

All Cap Head Bolts must have a Spring Washer and Washer before feeding through a hole. A washer will also need to be placed behind the hole before the nut.

**NOTE**

The back of the L-Joints face away from the panel's longitudinal center.

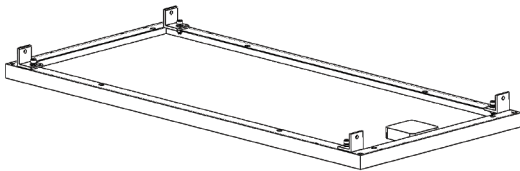
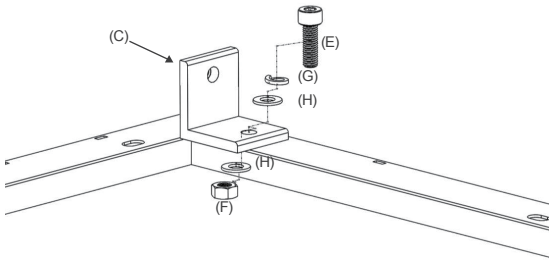



## ■ Attach L-Joint to L-Bracket Foot

NOTE

The mounting angle demonstrated in the image is to serve as a guide for users and their individual assemblies.

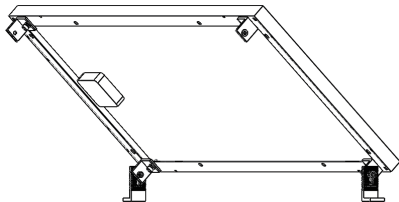
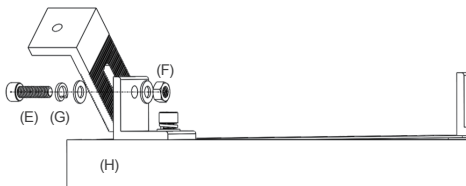

---

■ Attach Extension Bracket to L-Joint

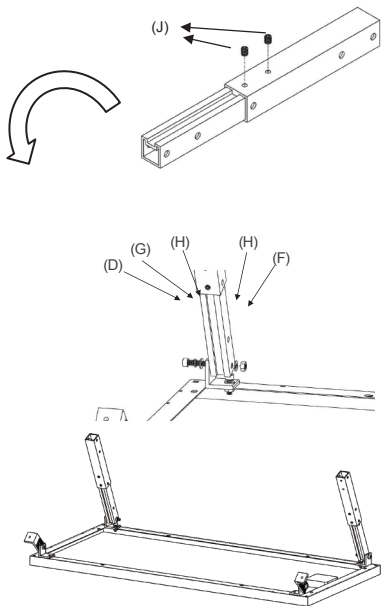

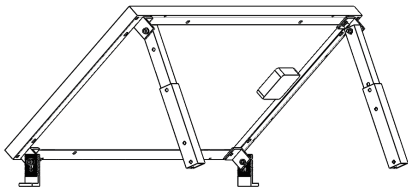

#### ■ Attach L-Bracket Foot to Extension Bracket

NOTE

The mounting angle of the Extension bracket relative to the L-Joint can change based on user needs.

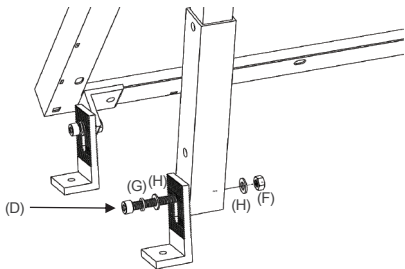

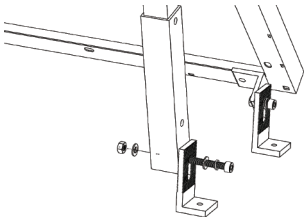

## Mounting Recommendations

**NOTE**

The following information is intended to be a basic guide to give the user a basic approach to mounting. A proper roof-mounting guide should be consulted prior to beginning any installation.

There are various fastening techniques, but some of the most common situations call for the use of a lag bolt. This method is common when mounting panels onto a roof with a wood or asphalt surface. The following is a basic approach and should be taken as such.

1. Find a desired mounting location
2. Drill 4 holes where the holes on the L-Bracket Feet line up. A power drill with a sufficient drill bit should be utilized in this process.
3. After the hole has been drilled, silicone sealant needs to be administered to the hole in order to prevent leaks.
4. Use a power drill with socket extension to drill the lag bolt into the hole.
5. Drill until sufficient load is applied.

# Dimensions

NOTE

The following drawings utilize inches as their dimension units.

■ Inner Extension Bracket

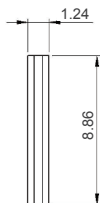

■ Outer Extension Bracket

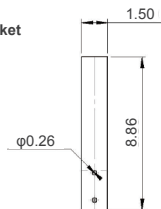

■ L-Foot

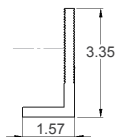
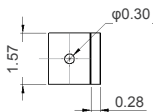

■ L-Joint

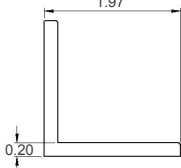
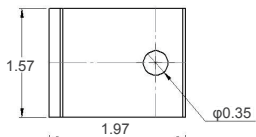

## Compatibility

The following chart represents the Renogy Modules for which this Tilt Mount works for and is optimized for. Optimization of the module implies that there are more degrees of freedom tilting.

<b>RENOGY Solar Module</b>	<b>Compatibility*</b>
RNG-10D-SS	IMCOMPATIBLE
RNG-30D-SS	IMCOMPATIBLE
RNG-50D-SS	OPTIMIZED
RNG-100D-R-BK	OPTIMIZED
RNG-100D-SS	OPTIMIZED
RNG-100MB	OPTIMIZED
RNG-160D-SS	WORKS
RNG-175D	WORKS
RSP200D	WORKS
RNG-270P	WORKS
RNG-300D	WORKS
RNG-320D	WORKS

**US** |  2775 E Philadelphia St, Ontario, CA 91761, USA  
 909-287-7111  
 [www.renogy.com](http://www.renogy.com)  
 [support@renogy.com](mailto:support@renogy.com)

**CN** |  苏州高新区科技城培源路1号5号楼-4  
 400-6636-695  
 <https://www.renogy.cn>  
 [support@renogy.cn](mailto:support@renogy.cn)

**JP** |  <https://www.renogy.jp>  
 [supportjp@renogy.com](mailto:supportjp@renogy.com)

**CA** |  <https://ca.renogy.com>  
 [supportca@renogy.com](mailto:supportca@renogy.com)

**AU** |  <https://au.renogy.com>  
 [supportau@renogy.com](mailto:supportau@renogy.com)

**UK** |  <https://uk.renogy.com>  
 [supportuk@renogy.com](mailto:supportuk@renogy.com)

**DE** |  <https://de.renogy.com>  
 [supportde@renogy.com](mailto:supportde@renogy.com)