

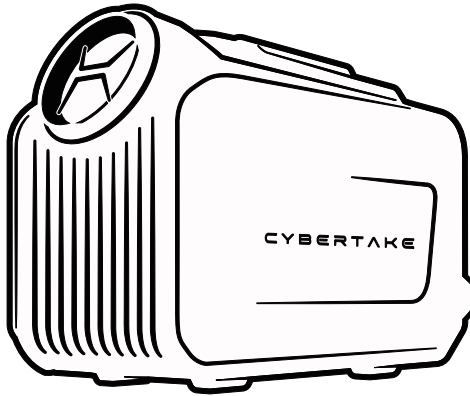

THE

FOURTH SPACE
CYBERTAKE AIR CONDITIONER

USER MANUAL



Please read this manual carefully before use

User Manual

Please read the user manual of this product carefully before use to ensure proper use after full understanding. After reading, please keep the user manual for future reference. In the case of complying with laws and regulations, our company reserves the right of final interpretation.

We are constantly iterating and upgrading our products, which may change different program software in the process. If you find any discrepancies in the information, please contact our customer service staff directly, or follow **The fourth space- WeChat official account** to obtain the latest product information.

Thank you for your understanding and support .

1. Product Specification

Basic Information

Product name: Outdoor air conditioner	Product model: S2 Pro
Product size: 473*260*356mm	Refrigerant/injection volume: R290/110g
Front and rear circulating air volume: 220/260 m ³ /h	Noise level: ≤55dB(A)
Net weight: about 13kg (built-in AC version), about 11.6kg (48V DC version)	

Input Specification (built-in AC version)

AC Input Voltage/Frequency: 220-240V~50Hz
Input Power: 550W Max

DC Adapter Specification (48V DC version)

Adapter Input: 100-240V~50/60Hz 7.0A
Output Power: 48V / 11.5A
Input Power: 600W Max

Refrigeration Specification

Temperature setting range: 16°C~28°C
Cooling capacity: 5100Btu/h (1500W)
Rated cooling input power: 500W
Maximum cooling input power: 550W

Heating Specification

Temperature setting range: 16~32 °C
Heating capacity: 6100Btu/h (1800W)
Maximum heating input power: 550W



2. Precautions

This manual describes the important safety precautions for the proper use and maintenance of air conditioners, and in order to prevent personal injury or property damage to users and others, please read the text with a full understanding of the following contents, and be sure to observe the safety precautions stated.

- The product must be repaired or maintained by a professional, and it is forbidden to disassemble, modify, repair or clean the internal components without authorization.
- Children and persons lacking physical, sensory, and mental abilities, as well as adults who do not understand the contents of this manual, should not operate this air conditioner.
- The air conditioner must be disconnected before cleaning or other maintenance. The accumulation of combustible gas may cause a fire, so do not install this air conditioner in a place where combustible gas is exposed.

- Do not cover the cord with carpet or similar covering, do not place the cord under furniture or other appliances, and place the cord away from traffic or where it is tripped.
- Turn off the air conditioner during a thunderstorm when using it outdoors to avoid damage to the air conditioner by lightning strikes.
- During the working process of the air conditioner, do not cover the front and rear air outlets, front and rear air inlets, and do not use the front and rear air outlets to air dry and dry objects and clothes.
- Please place the air conditioner on a sturdy flat surface, otherwise it may cause damage or excessive noise and vibration.
- Do not operate the air conditioner by dropping or damaging it.
- The installation must be done in accordance with the installation instructions. Improper installation can result in water ingress, leakage, electric shock, or fire.
- Install only with the included accessories and parts and the specified tools. The use of non-standard parts may result in water leakage, electric shock, fire, injury, or property damage.
- Please make sure that the outlet you are using is grounded and the voltage is appropriate. Equipped with a power cord with a three-pin grounding plug to protect against electric shock.
- It is forbidden to replace the power cord without authorization. Or connect the power cord halfway, or use it in parallel with other electrical appliances. Improper use of the power supply can cause fire or electric shock.
- If the power cord is damaged, it must be replaced by the manufacturer, maintenance department or a professional to avoid danger.
- Do not install the air conditioner in a humid room such as a bathroom or laundry room, as this may cause a short circuit in the electrical components.
- To reduce the risk of fire or electric shock, do not use the air conditioner with any solid-state speed control device.
- This air conditioner is strictly forbidden to be dumped.
- This air conditioner does not support users to add refrigerants by themselves.
- The maintenance or repair of this air conditioner must be carried out by a certified technician.
- After the air conditioner is scrapped, please separate it from the household garbage, the scrap must comply with the local garbage disposal regulations, and the power cord must be cut off before scrapping, and the equipment cannot be reused.

Note: All pictures in this manual are for reference only, your air conditioner may be slightly different due to the model, please refer to the actual product.

3. Product Appearance

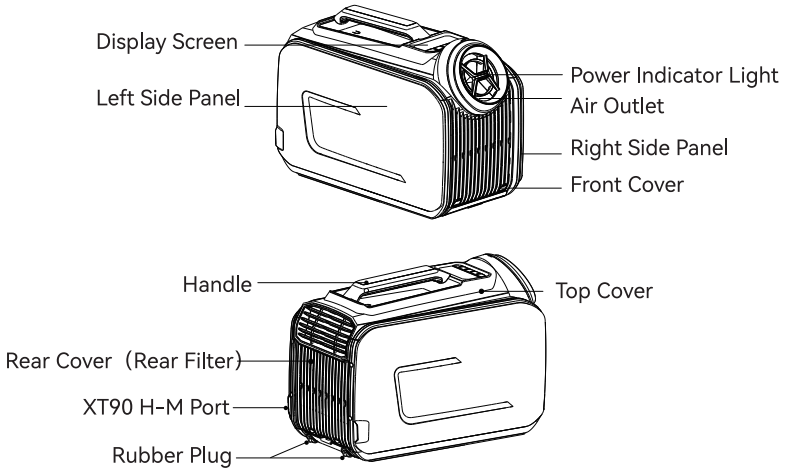

4. Introduction to the display screen and buttons

4.1 Introduction to Buttons

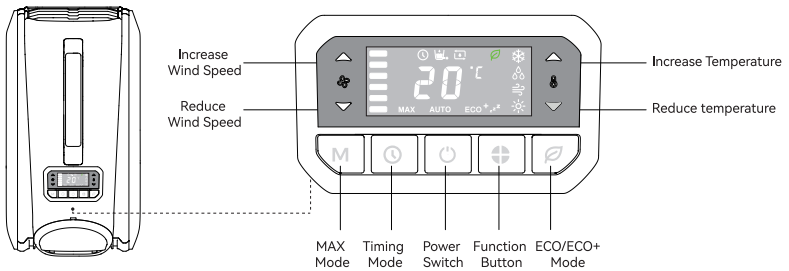

4.2 Introduction to Display Icons

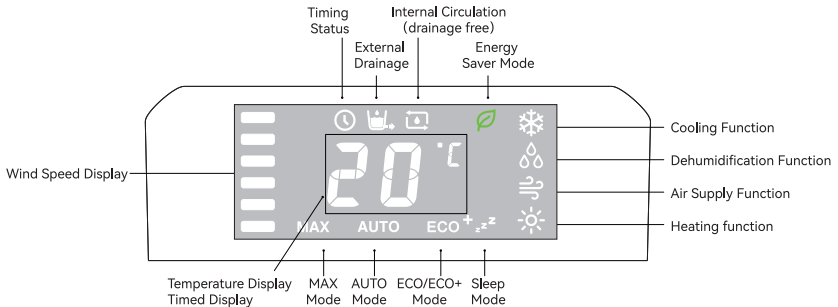

5. Product Function Description

5.1 Power On and Off

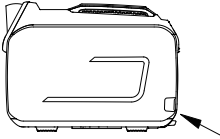

Note: Please connect the XT90 female terminal on the adapter to the XT90 male terminal on the air conditioner first, and then plug the AC power cord on the adapter into the power supply. (Please refer to Appendix 1 for the power supply methods of different versions of air conditioners. If you have any questions, please consult customer service.)

Access Dedicated Adapter

- (1) Press and hold the power button for 1 second to start the air conditioner, the buzzer "beeps", the power light is on, the blue display is in normal operation, and the red display is displayed when there is an abnormal alarm.
- (2) Every time the air conditioner is turned on and the screen wakes up, the display screen will first display the current ambient temperature, and then display the setting temperature.
- (3) Press and hold the key for 2 seconds to turn off the air conditioner.

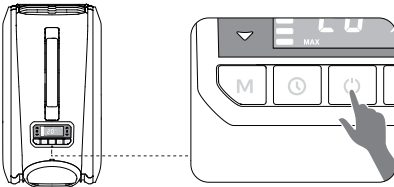

5.2 Function and Mode Adjustment

Short press the function button to select cooling, dehumidification, air supply, and heating function.

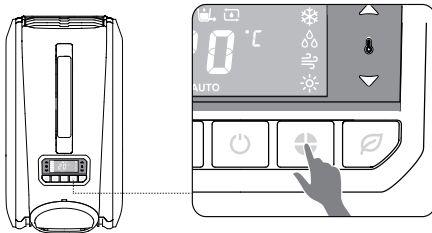

5.2.1 In Cooling mode:

Can select MAX mode, ECO+sleep mode, ECO energy-saving mode, and AUTO mode by short pressing the corresponding button.

- MAX mode: Press the MAX button to enter the fast cooling mode, then short press the MAX button again to switch to AUTO automatic mode. At this time, both wind speed and temperature can be adjusted.

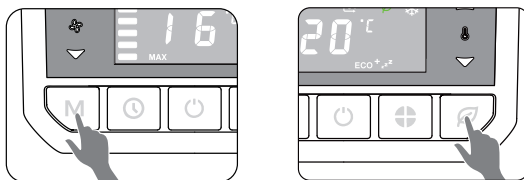

- ECO+sleep mode: Short press the ECO button once to enter ECO+sleep mode, and the wind speed and temperature can be adjusted.
- ECO energy-saving mode: Short press the ECO button twice to enter ECO energy-saving mode, and the wind speed and temperature can be adjusted.
- AUTO mode: Short press the ECO button three times or the MAX button two times to switch to AUTO mode. And the wind speed and temperature can be adjusted.

The above cycle in turn.

5.2.2 In dehumidification mode, the wind speed is adjustable, but the temperature is not adjustable.

Note: In dehumidification mode, the product needs to be moved indoors for use, and heat dissipation pipes should be installed at the same time to allow steam to be discharged outside.

5.2.3 In the air supply mode, the wind speed is adjustable, but the temperature is not adjustable.

5.2.4 Under the heating function, the temperature and wind speed can be adjusted, and MAX mode and AUTO mode can be selected, the other modes are not available.

5.3 Wind Speed Adjustment

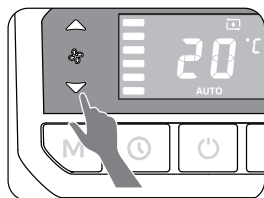

There are 6 wind speed levels, press the ▲UP (increase) button and ▼DOWN (reduce) key to select the wind speed you need.

5.4 Temperature Adjustment

The temperature setting value can be changed by pressing the ▲UP (increase) and ▼DOWN (reduce) button, and the setting range is :

Cooling Function: 16~28°C (60~82°F) , with an interval of 1°C/1°F .

Heating Function: 16~32°C (60~90°F) , with an interval of 1°C/1°F .

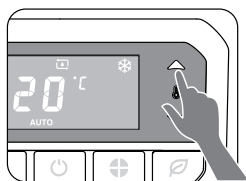

5.5 Timing Adjustment

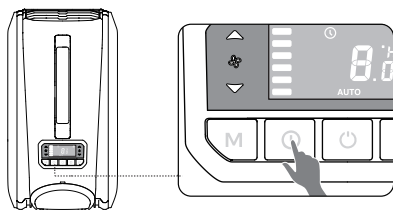







Press the timer button to enter the adjustment page for timed off air conditioner.

- By pressing the timing button, the timing can be set from 0 to 12 hours. Short press to increment, long press to scroll.
- When the timer page shows the time you need, please release the button, and the air conditioner will directly enter the timer state.
- After completing the timer setting, press and hold the timer button for 2 seconds to reset the timer to zero and reset it.
- When the air conditioner is turned on, press the timer button twice in a row to directly time it for 1 hour.

5.6 Change the temperature unit

Press and hold both the air volume and temperature increase ▲ buttons at the same time can change the temperature units : Celsius-°C ↔ Fahrenheit-°F .

5.7 Drainage mode

- This air conditioner has two drainage modes: drainage-free mode (internal circulation) and external drainage mode. The factory default is external drainage mode.
Short press the **M** key and  key at the same time: turn on the water pump, start the drainage-free mode, and the icon  on the screen lights up.
Short press the **M** key and  key at the same time: turn off the water pump and enter the external drainage mode, the icon  on the screen goes out, and the water pipe must be connected for drainage operation.
- When the ambient humidity is high and the condensation water of the air conditioner cannot be completely discharged by the internal circulation system, the air conditioner buzzer will alarm and remind you. At the same time, the drainage-free icon  and the external drainage icon  will flash alternately to remind you to connect the drainage pipe for active drainage. If the water is not drained in time, the compressor will stop working and resume after the alarm is lifted.

Note: To avoid water overflow in the air conditioner, please place it horizontally when using it. The air conditioner has a built-in water pump, which can achieve the function of no drainage, but it is recommended to connect a drain pipe to assist drainage when the ambient humidity is high.

5.8 Wireless Connected

- Depending on the air conditioner model, you can connect to the APP wirelessly. For details, please contact customer service for operating instructions.

5.9 Memory Function

This air conditioner comes with a memory function. After the air conditioner is shut down and restarted normally, the settings of the previous use are directly followed.

5.10 Attached "List of Air Conditioner Modes"

Function	Mode	Wind Speed Adjustment	Temperature Adjustment	Mode Adjustment
Cooling Function	AUTO Mode	√	√	√
	MAX Mode	√	√	√
	ECO Mode	√	√	√
	ECO+sleep Mode	√	√	√
Dehumidification Function		√	×	×
Air Supply Function		√	×	×
Heating Function		√	√	√

Note: Under the heating function, MAX mode and AUTO mode can be selected, and the other modes are not available.

6. Installation of Accessories

6.1 Installation of front hood and air duct

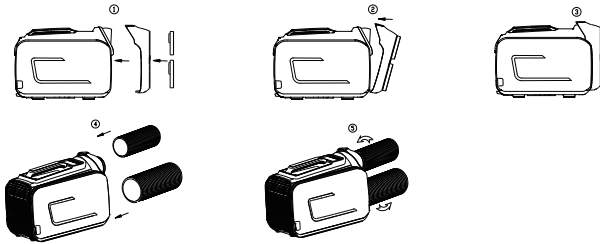

6.2 Installation of rear hood and air duct

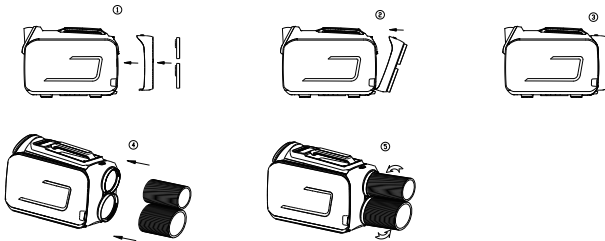

6.3 Drain-pipe Installation

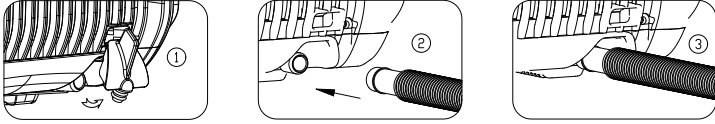

This air conditioner has two drainage outlets on the left and right, which can be installed for external drainage according to needs.

7. Usage Scenarios

The installation location of the air conditioner should meet the following requirements:

- Make sure the air conditioner is installed on a flat surface to minimize noise and vibration.
- Make sure that the distance between the air outlet of the air conditioner and the obstacle is $> 30\text{cm}$, and the distance between the rear exhaust port and the obstacle is $> 100\text{cm}$.

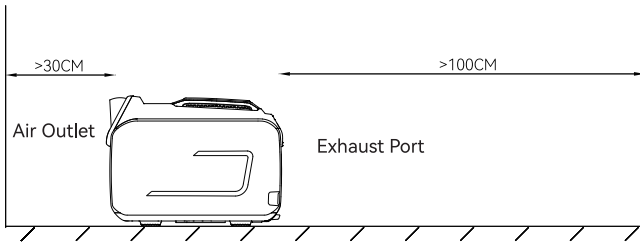

- It is strongly recommended that the air conditioner be kept horizontally with a maximum inclination angle of no more than 10° , otherwise it will affect the normal operation of the air conditioner.

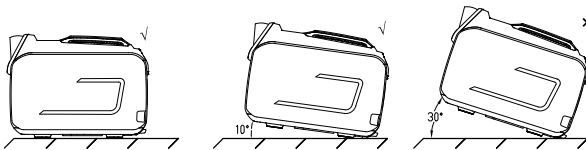

⚠ Warn:

If it is transported over a long distance, please be sure to place it horizontally for 2-3 hours before turning on the air conditioner each time before turning it on.

8. Fault Diagnosis

Code	Fault Description	Solution
F0	Water pump malfunction	Disconnect the power supply and restart the air conditioner
F1	Display board communication failure	Disconnect the power supply and restart the air conditioner
F2	Hardware overcurrent protection	Disconnect the power supply and restart the air conditioner
F3	Rear fan feedback fault	Disconnect the power supply and restart the air conditioner
F4	Front fan feedback fault	Disconnect the power supply and restart the air conditioner
F5	Bluetooth communication failure	Disconnect the power supply and restart the air conditioner
F6	Water level sensor malfunction	Disconnect the power supply and restart the air conditioner
E0	Inlet air sensor malfunction	Disconnect the power supply and restart the air conditioner
E1	Evaporator sensor malfunction	Disconnect the power supply and restart the air conditioner
E2	Exhaust sensor malfunction	Disconnect the power supply and restart the air conditioner
E3	Exhaust overheat protection	Disconnect the power supply and restart the air conditioner
E4	Evaporator subcooling protection	Disconnect the power supply and restart the air conditioner
E5	Overvoltage protection	Disconnect the power supply and restart the air conditioner
E6	Undervoltage protection	Disconnect the power supply and restart the air conditioner
E7	Phase-loss protection	Disconnect the power supply and restart the air conditioner
E8	Stall protection	Disconnect the power supply and restart the air conditioner
E9	Phase current anomaly protection	Disconnect the power supply and restart the air conditioner
EA	Software overcurrent protection	Disconnect the power supply and restart the air conditioner

Note: If the fault cannot be solved after dealing with the above solutions, please contact the after-sales personnel directly.

9. Precautions For Use

- The air conditioner has a built-in water pumping motor, which can realize internal circulation drainage, but when the ambient humidity is high, it needs to be connected to the drain pipe to assist in drainage.

- In order to avoid frequent start and stop of the compressor, there will be at least 1 minute of shutdown time after the compressor is turned off, and it is normal for the compressor to not operate within 1 minute when the machine is switched on and off in a short period of time.

10. Package Contents

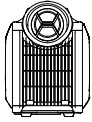

Air Conditioner
x1

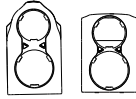

The Front Hood x 1
Rear Hood x 1



Hood Accessory A x 1
Hood Accessory B x 1

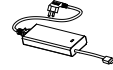

Adapter x 1
(Adapter version)



Air Duct x 1
D:11cm,L:150cm



Air Duct x 1
D:13cm,L:150cm



Drain-pipe x 1
D:1.8cm,L:100cm



User Manual x 1
Warranty Card x 1
Thanks Card x 1

11. Cleaning and maintenance

- Before cleaning and maintenance, the machine must be stopped and the power supply must be cut off.
- Do not use flammable liquids or chemicals to clean this air conditioner, and under no circumstances should this air conditioner be immersed in any liquid.
- Filter Cleaning:
This air conditioner includes front and rear filters, which can be removed as shown as below, take out the filter and clean it. After cleaning, put it back in place.

Rear Filter:
(Rear Cover)

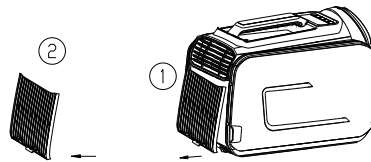

Front Filter:

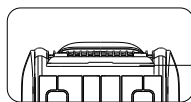

Filter

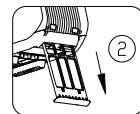
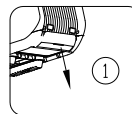

- Transportation & Loading:
After the air conditioner is used, since there is still condensation inside, please open the drain hole for drainage, and wipe the residual water of the body with a dry towel before transportation and loading.

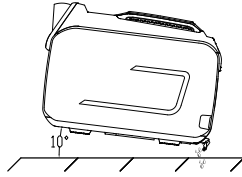

12. Appendix 1- Instruction of Air Conditioner Power Supply Method

According to different versions of air conditioner, there are three power supply methods as follows. Please refer to the actual model and accessories purchased for details. If you have any questions, please contact customer service directly.

- Method 1:
Connect AC power or mains power

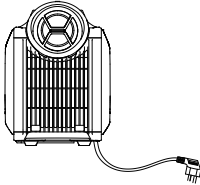

100-240V AC power supply/mains power

- Method 2:
Connect the DC Power Adapter

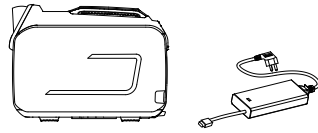

The dedicated 48V power adapter

- Method 3: Connect the boost DC converter

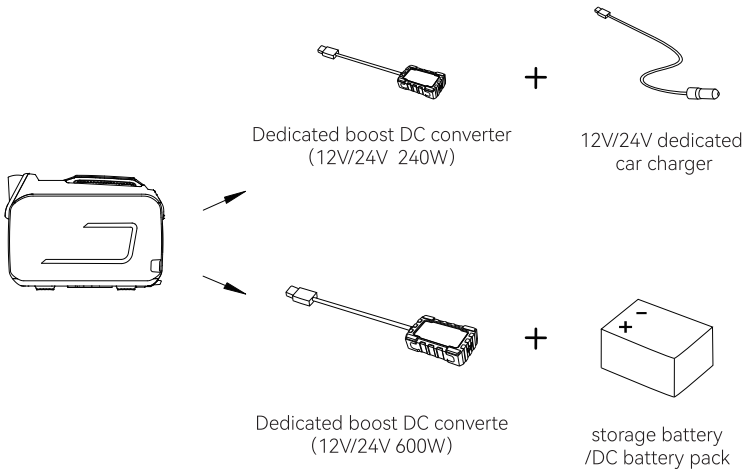

Note: For more relevant accessories under continuous development, please follow the official account for the latest information.

13. Appendix 2- Remote Control Instructions (Remote Control Version Only)

The following content is only applicable to the remote control version. If you have any questions, please contact customer service directly.

13.1 Introduction to remote control buttons

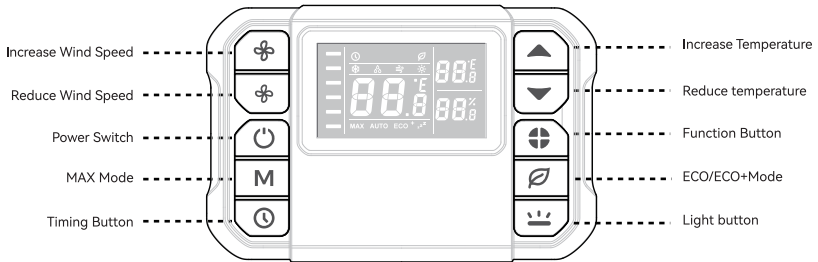

13.2 Introduction to Remote Control Display Screen Icons

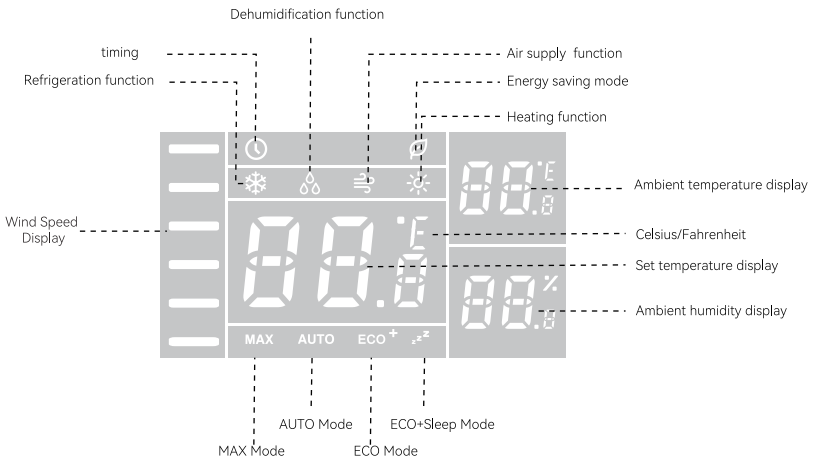

13.3 Operating instructions

- **Matching connection:**
 - ① Install the battery into the remote control and turn on the remote control;
 - ② When the air conditioner is turned on, press and hold the ECO button on the air conditioner for 6 seconds to enter pairing mode. When -- is displayed on the screen, press any key on the remote control to complete the matching.
- **On/Off button:** Press and hold for 1 second to turn on the air conditioner, and press and hold for 2 seconds to turn off the air conditioner.

- **Function button:**
Short press the function button to select cooling, dehumidification, air supply, and heating functions.
Note: The heating function is applicable to both cold and warm models. Please contact customer service for more information.
- **Mode selection:** In the cooling function,
Can choose MAX mode, ECO+sleep mode, ECO energy-saving mode, and AUTO mode.
Short press the MAX button once to enter MAX mode, and short press again to enter AUTO mode.

Short press the ECO button once to enter ECO+sleep mode, short press twice to enter ECO energy-saving mode, short press three times to enter AUTO mode.

The above cycles in sequence.

- **Timer button:** Can be set to turn off the air conditioning at a fixed time within 0-12 hours; Long press the timer button to enter the timer mode, Short press the $\Delta \nabla$ button to increment/decrement, long press to scroll through numbers; After completing the timer setting, press and hold the timer button for 2 seconds to reset the timer to zero and reset it.
When the air conditioner, press the timer button twice in a row can directly time for 1 hour.
- **Light on/off button:** Short press the light button to turn on/off the screen and the power indicator light on the air conditioner.
- **Wind speed increase/reduce button:** There are a total of 6 levels of wind speed, which can be adjusted by short pressing the increase/reduce button.
- **Temperature increase/reduce button:** Short press the temperature increase/reduce button to adjust the temperature. The temperature setting range is:
Cooling Function: 16~28°C (60~82°F), with an interval of 1°C/1°F.
Heating Function: 16~32°C (60~90°F), with an interval of 1°C/1°F.
- **Change the temperature unit:**
The default temperature unit is Celsius - °C, press and hold the light button for 3 seconds to switch to Fahrenheit - °F.

13.4 Other Function Description

- **Screen display function:**
Press any button to turn on or off the screen. After 30 seconds of inactivity, turn off the screen display.
- **Temperature and humidity display:**
The remote control is equipped with a temperature and humidity sensor, which will display the current ambient temperature and humidity on the screen.
Due to changes in the actual usage environment, there may be errors.
The values are for reference only and cannot be used as measuring tools.
- **Magnetic adsorption function:**
The remote control is equipped with a built-in magnet, which can be directly magnetically attached to the indicated position below the air conditioning handle or any magnetic object to avoid loss.
- **Power supply:** Use 2 pieces LRO3 AAA (1.5V) batteries.

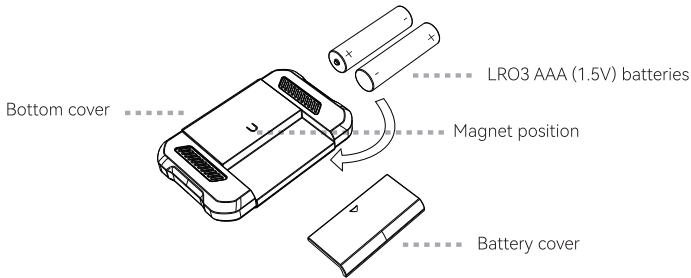

13.5 Note:

- This remote control is not waterproof and should not be submerged in water.
- When not using the remote control for a long time, please remove the battery.
- Please replace the batteries according to the specified model and dispose of the used batteries in accordance with relevant national regulations.
- The operation of the product host button and remote control should not completely turn off the air conditioning power. If the air conditioner is not used for a long time, please unplug the power plug.

14. Warning

⚠ Changes or modifications not expressly approved by the party responsible for compliance could void the user's authority to operate the equipment. This device complies with Part 15 of the FCC Rules. Operation is subject to the following two conditions:

- (1) This device may not cause harmful interference, and
- (2) This device must accept any interference received, including interference that may cause undesired operation.

⚠ Note: This equipment has been tested and found to comply with the limits for a Class B digital device, pursuant to Part 15 of the FCC Rules. These limits are designed to provide reasonable protection against harmful interference in a residential installation. This equipment generates, uses, and can radiate radio frequency energy, and if not installed and used in accordance with the instructions, may cause harmful interference to radio communications. However, there is no guarantee that interference will not occur in a particular installation. If this equipment does cause harmful interference to radio or television reception, which can be determined by turning the equipment off and on, the user is encouraged to try to correct the interference by one or more of the following measures:

- Reorient or relocate the receiving antenna.
- Increase the separation between the equipment and receiver.
- Connect the equipment into an outlet on a circuit different from that to which the receiver is connected.
- Consult the dealer or an experienced radio/TV technician for help.

This air conditioner is produced by Fourth Space Co., LTD.
Service hotline: 400-616-7796